

# Automaten Hoffmann Billardtisch „Olympic“

Automaten Hoffmann Pool Table „Olympic“

**Aufbauanleitung/Assembly manual:**  
Art. 7147/3153/6097/6091/6093/6095

**Billard**

**D**

**Herzlichen Glückwunsch! Wir hoffen Sie werden viel Spaß mit Ihrem neuen Kickertisch haben!**



**Please keep your instructions!**

- Sie brauchen Ihre Seriennummer wenn Sie uns kontaktieren.
- Bitte lesen Sie sich vor der Montage die Anleitung sorgfältig durch und machen sich mit den Bauteilen vertraut
- Bitte überprüfen Sie vor Beginn der Montage ob alle Teile vollständig sind.



**Kontakt Information:**

Automaten Hoffmann GmbH  
 Im Teelbruch 77  
 45219 Essen-Kettwig  
 Telefon: 02054 16738  
 www.automaten-hoffmann.de



**Warnung!**

- Bitte bewahren Sie Schmiermittel und Bälle außerhalb der Reichweite von Kindern auf
- Sprühen Sie das Schmiermittel nicht auf Personen oder Tiere Lassen Sie Ihre Kinder nicht unbeaufsichtigt mit dem Kickertisch spielen
- Bitte seien Sie im Umgang mit den Kickerstangen vorsichtig um Verletzungen zu vermeiden
- Bitte lesen Sie die Aufbauanleitung sorgfältig um Verletzungen oder Beschädigungen zu vermeiden



**Folgende Werkzeuge werden zur Montage benötigt:**

- Schlitzschraubenzieher, Kreuzschlitzschraubenzieher, Akkuschauber, nicht enthalten
- Werkzeug für Spannstift (# 21), Innensechskant-Schlüssel (#14) (enthalten)

**GB**

**Congratulations! We hope you will have many hours to use your new soccer table and enjoy the pleasure it brings to you !**



**Bitte halten Sie sich an die Aufbauanleitung**

- Your Model number is needed when you contact us.
- Please read through this instruction book to familiarize yourself with all the parts and assembly steps.
- Please find the attached tables for all the parts' name, specification and quantity.



**Contact Information:**

Automaten Hoffmann GmbH  
 Im Teelbruch 77  
 45219 Essen-Kettwig  
 Telefon: 02054 16738  
 www.automaten-hoffmann.de



**Warning!**

- Please keep the balls, lubricant and other parts out of children's reach.
- Don't spray the lubricant to any person or animal.
- This is not a child's toy. Adult supervision is required for children playing this game.
- please take care to avoid injuring any thing or person when you push and pull the player rods .
- Please read instructions carefully. Proper use of this set can avoid damage or injury .









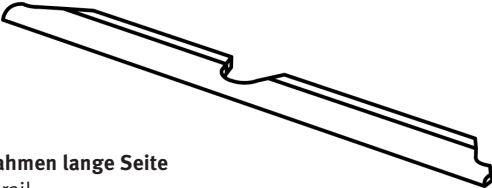
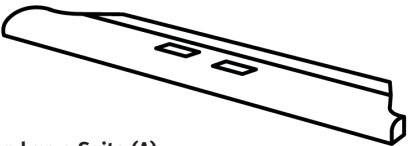
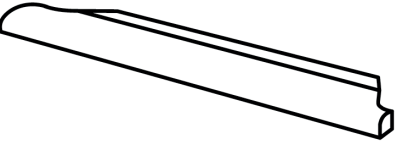
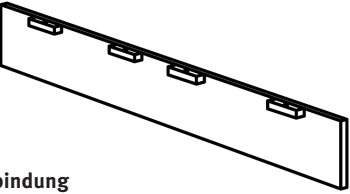
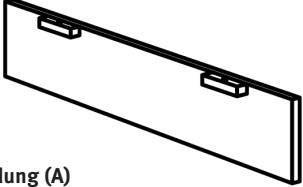
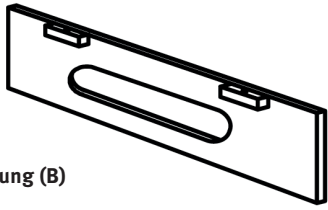
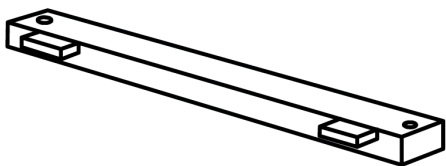
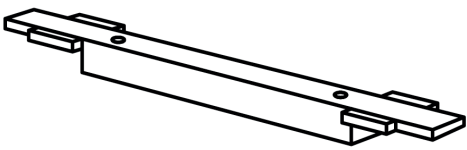
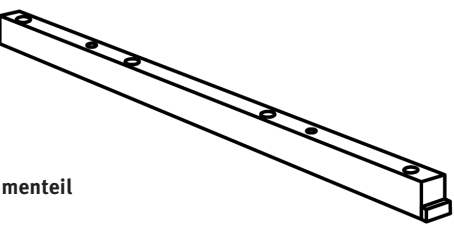
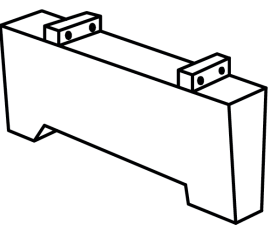
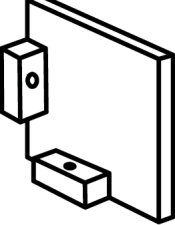
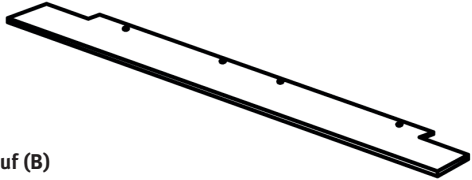
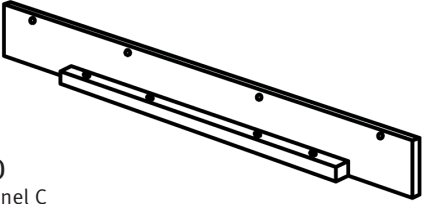

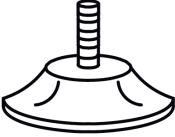
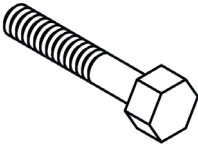
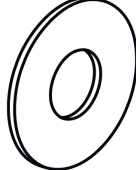
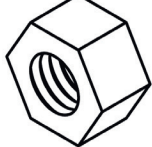
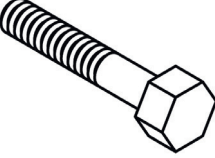
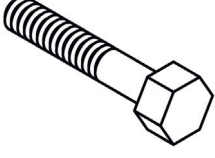
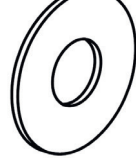
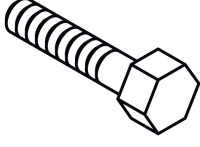

**Tools required for assembly:**

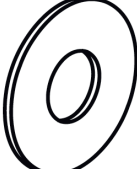
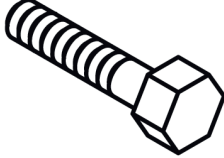
- Phillips and Slotted Head Screwdrivers , Power Driver or Hammar(not included)
- Roll Pin Punch (#21), Allen Key (#14) (included)

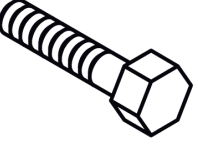
**Bauteile / Parts list:**

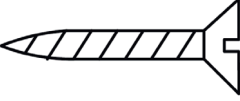
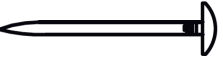
<p><b>A</b> 2x</p>  <p><b>Bandenrahmen lange Seite</b> Long top rail</p>	<p><b>B</b> 1x</p>  <p><b>Bandenrahmen kurze Seite (A)</b> End top rail (A)</p>
<p><b>C</b> 1x</p>  <p><b>Bandenrahmen kurze Seite (B)</b> End top rail (B)</p>	<p><b>D</b> 2x</p>  <p><b>Lange Seitenverbindung</b> Long apron</p>
<p><b>E</b> 1x</p>  <p><b>Kurze Seitenverbindung (A)</b> End apron (A)</p>	<p><b>F</b> 1x</p>  <p><b>Kurze Seitenverbindung (B)</b> End apron (B)</p>
<p><b>G</b> 2x</p>  <p><b>Querstrebe</b> Cross Member</p>	<p><b>H</b> 2x</p>  <p><b>Mittlere Querstrebe</b> Mid Cross Member</p>
<p><b>I</b> 2x</p>  <p><b>Langes Rahmenteil</b> Long frame</p>	<p><b>J</b> 2x</p>  <p><b>Bein</b> Leg</p>
<p><b>K</b> 2x</p>  <p><b>Ballrücklauf (A)</b> Ball storage panel A</p>	<p><b>L</b> 1x</p>  <p><b>Ballrücklauf (B)</b> Ball storage panel B</p>
<p><b>M</b> 1x</p>  <p><b>Ballrücklauf (C)</b> Ball storage panel C</p>	

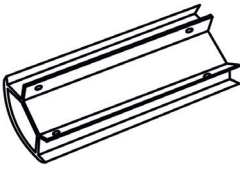
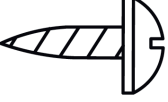
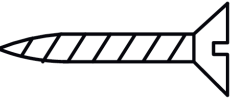
**Bauteile 2 / Parts list 2:**

<p><b>1</b> 4x</p>  <p><b>Höhenverstellbarer Fuß</b> Leg leveler</p>	<p><b>2</b> 8x</p>  <p><b>Schraube</b> M10x4-1/2" Bolt</p>	<p><b>3</b> 32x</p>  <p><b>Unterlegscheibe</b> 3/8"x25 mm washer</p>	<p><b>4</b> 16x</p>  <p><b>Mutter</b> M 10 mm nut</p>
<p><b>5</b> 8x</p>  <p><b>Schraube</b> M10 x 180 mm bolt</p>	<p><b>6</b> 4x</p>  <p><b>Schraube</b> M12 x 140 mm bolt</p>	<p><b>7</b> 4x</p>  <p><b>Unterlegscheibe</b> 13 x 28 mm washer</p>	<p><b>8</b> 30x</p>  <p><b>Schraube</b> 5/16" x 1-3/4" bolt</p>
<p><b>9</b> 12x</p>  <p><b>Unterlegscheibe</b> 5/16" x 23 mm Washer</p>	<p><b>10</b> 18x</p>  <p><b>Unterlegscheibe</b> 5/16" x 35 mm Washer</p>	<p><b>11</b> 8x</p>  <p><b>Schraube</b> 1/4" x 1" Bolt</p>	<p><b>12</b> 8x</p>  <p><b>Unterlegscheibe</b> 1/4" x 32 mm Washer</p>
<p><b>13</b> 4x</p>  <p><b>Eckverbindung</b> Top corner</p>	<p><b>14</b> 8x</p>  <p><b>Schraube</b> 1/4" x 1-3/4" Bolt</p>	<p><b>15</b> 8x</p>  <p><b>Unterlegscheibe</b> 1/4" 19 mm Washer</p>	<p><b>16</b> 12x</p>  <p><b>Schraube</b> #12*2-1/2" Screw</p>
<p><b>17</b> 18x</p>  <p><b>Nagel</b> Nail</p>	<p><b>18</b> 6x</p>  <p><b>Ballfangtasche</b> Plastic pocket</p>	<p><b>19</b> 4x</p>  <p><b>Verblendung Ecke</b> Apron corner</p>	<p><b>20</b> 16x</p>  <p><b>Schraube</b> T4 x 12mm Screw</p>
<p><b>21</b> 4x</p>  <p><b>Schraube</b> F4*1-1/4" Screw</p>	<p><b>22</b> 1x</p>  <p><b>Schraubenschlüssel</b> Wrench</p>		

## Schritt 1

step 1

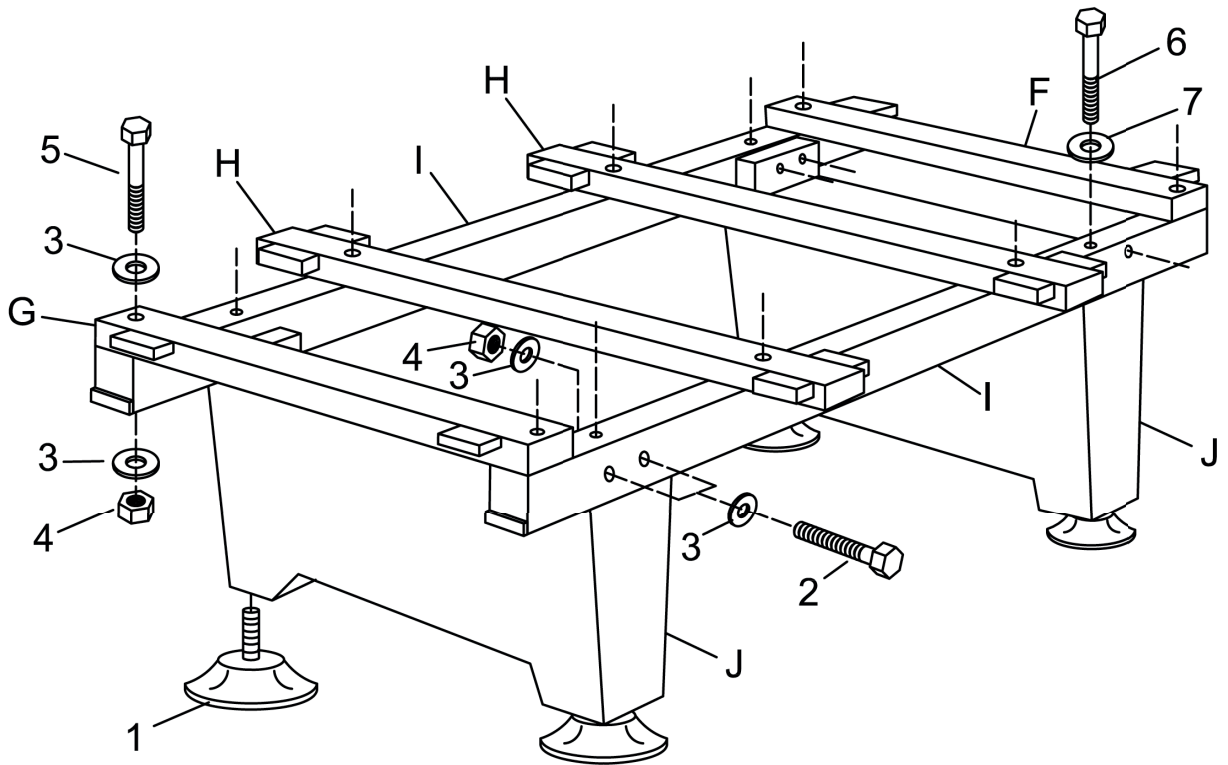

## Schritt 2

step 2

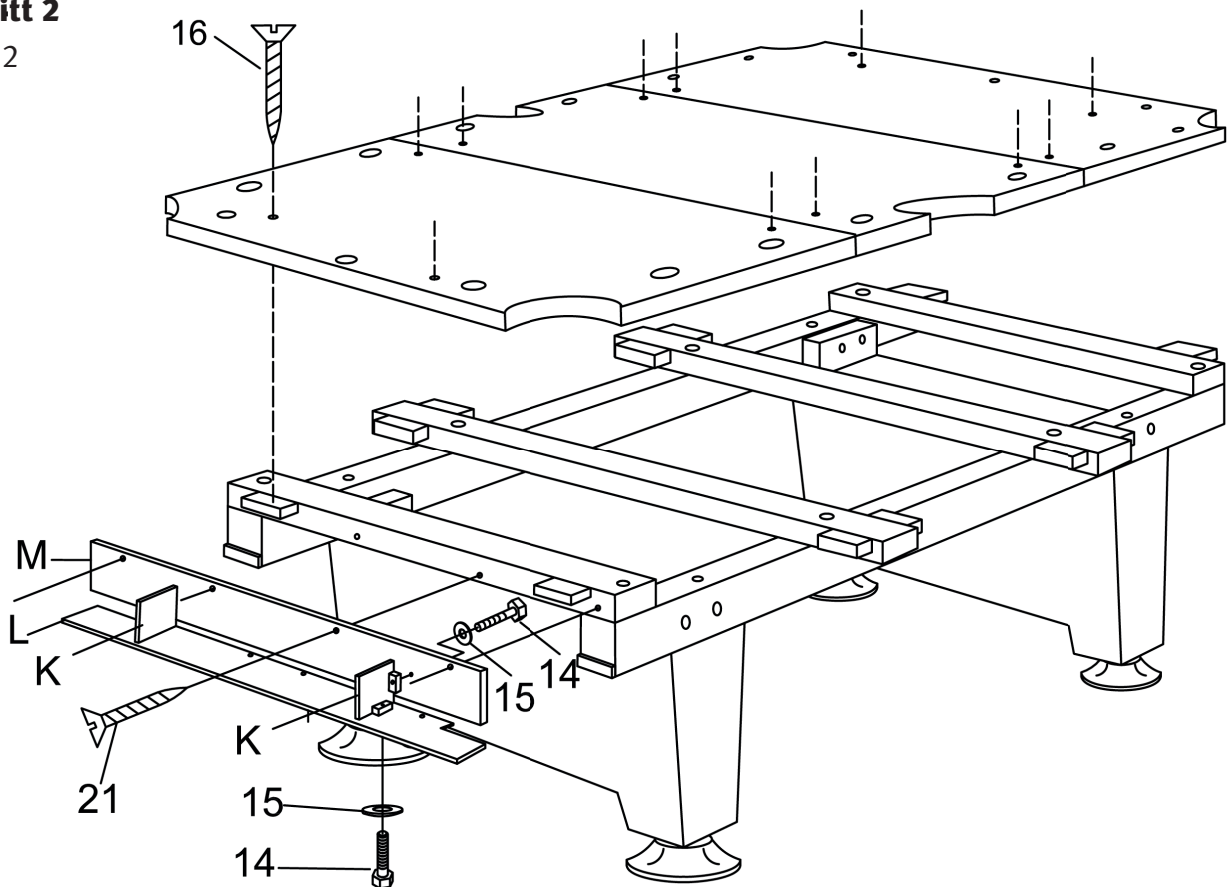

### Schritt 3

step 3

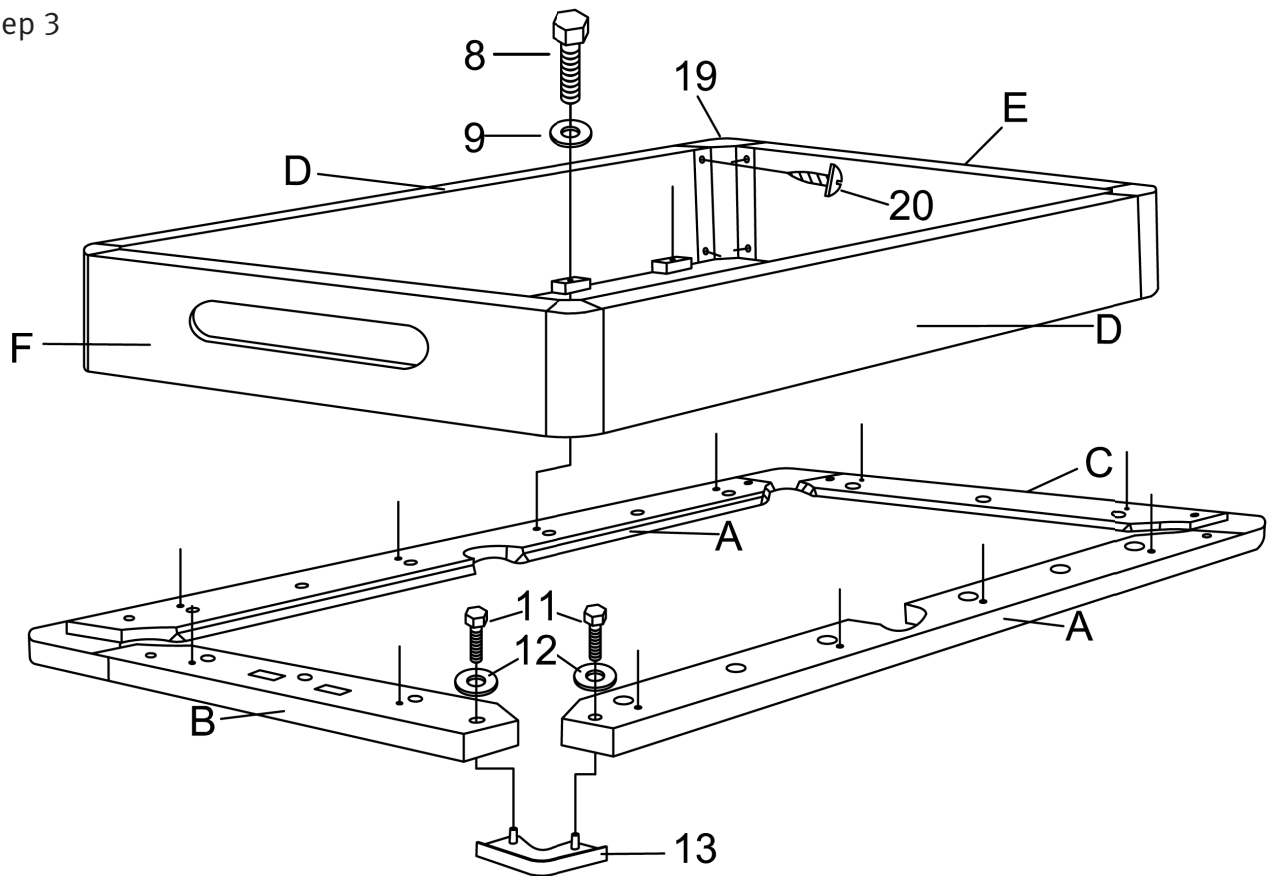

### Schritt 4

step 4

