

Automaten Hoffmann Billardtisch „Olympic“

Automaten Hoffmann Pool Table „Olympic“

Aufbauanleitung/Assembly manual: Art. 7148

Billard

D

Herzlichen Glückwunsch! Wir hoffen Sie werden viel Spaß mit Ihrem neuen Kickertisch haben!



Please keep your instructions!

- Sie brauchen Ihre Seriennummer wenn Sie uns kontaktieren.
- Bitte lesen Sie sich vor der Montage die Anleitung sorgfältig durch und machen sich mit den Bauteilen vertraut
- Bitte überprüfen Sie vor Beginn der Montage ob alle Teile vollständig sind.



Kontakt Information:

Automaten Hoffmann GmbH
 Im Teelbruch 77
 45219 Essen-Kettwig
 Telefon: 02054 16738
 www.automaten-hoffmann.de



Warnung!

- Bitte bewahren Sie Schmiermittel und Bälle außerhalb der Reichweite von Kindern auf
- Sprühen Sie das Schmiermittel nicht auf Personen oder Tiere Lassen Sie Ihre Kinder nicht unbeaufsichtigt mit dem Kickertisch spielen
- Bitte seien Sie im Umgang mit den Kickerstangen vorsichtig um Verletzungen zu vermeiden
- Bitte lesen Sie die Aufbauanleitung sorgfältig um Verletzungen oder Beschädigungen zu vermeiden



Folgende Werkzeuge werden zur Montage benötigt:

- Schlitzschraubenzieher, Kreuzschlitzschraubenzieher, Akkuschauber, nicht enthalten
- Werkzeug für Spannstift (# 21), Innensechskant-Schlüssel (#14) (enthalten)

GB

Congratulations! We hope you will have many hours to use your new soccer table and enjoy the pleasure it brings to you !



Bitte halten Sie sich an die Aufbauanleitung

- Your Model number is needed when you contact us.
- Please read through this instruction book to familiarize yourself with all the parts and assembly steps.
- Please find the attached tables for all the parts' name, specification and quantity.



Contact Information:

Automaten Hoffmann GmbH
 Im Teelbruch 77
 45219 Essen-Kettwig
 Telefon: 02054 16738
 www.automaten-hoffmann.de



Warning!

- Please keep the balls, lubricant and other parts out of children's reach.
- Don't spray the lubricant to any person or animal.
- This is not a child's toy. Adult supervision is required for children playing this game.
- please take care to avoid injuring any thing or person when you push and pull the player rods .
- Please read instructions carefully. Proper use of this set can avoid damage or injury .









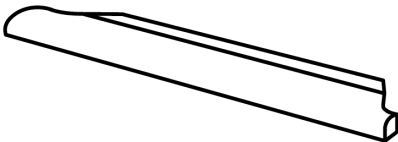
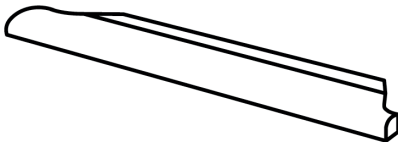
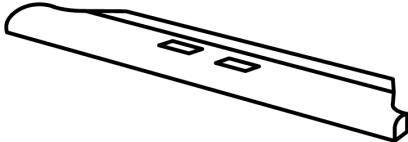
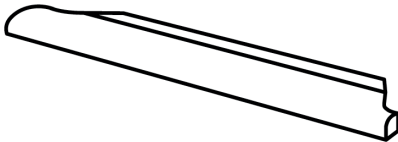
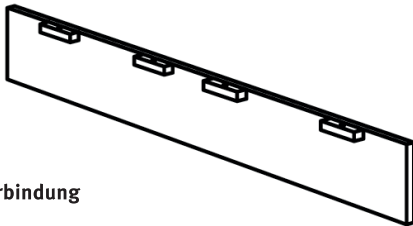
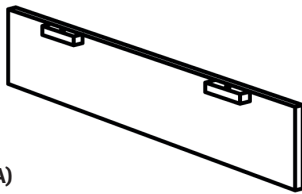
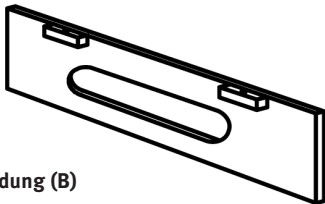
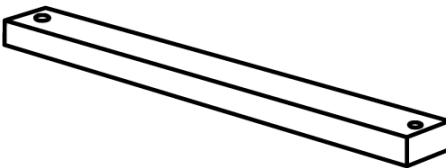
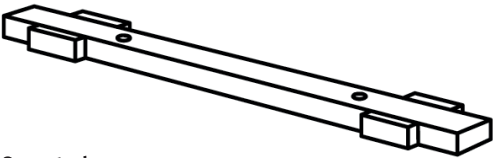
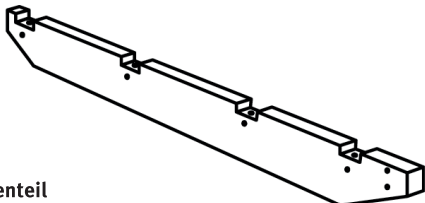
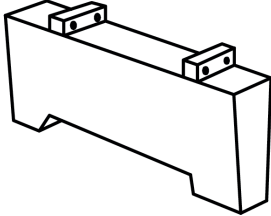
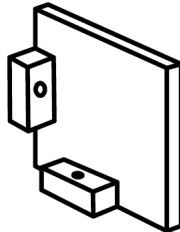
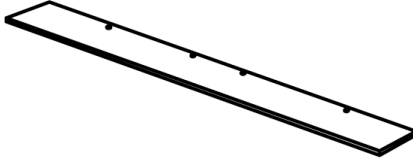
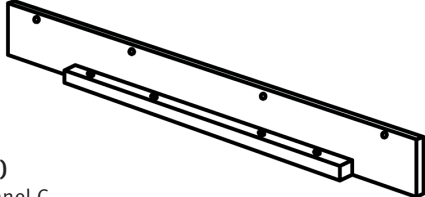

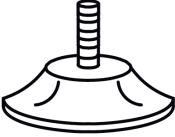
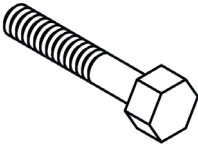
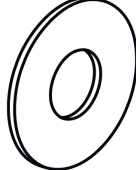
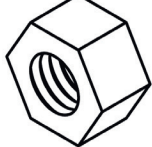
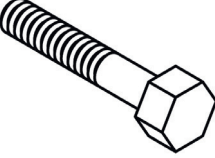
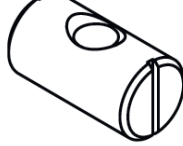
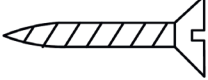
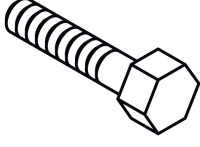

Tools required for assembly:

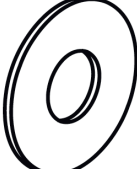
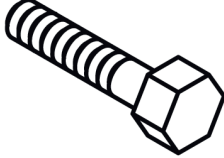
- Phillips and Slotted Head Screwdrivers , Power Driver or Hammar(not included)
- Roll Pin Punch (#21), Allen Key (#14) (included)

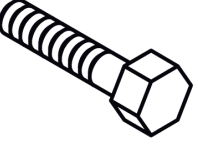
Bauteile / Parts list:

<p>A 2x</p>  <p>Bandenrahmen lange Seite (A) Long top rail (A)</p>	<p>B 2x</p>  <p>Bandenrahmen lange Seite (B) Long top rail (B)</p>
<p>C 1x</p>  <p>Bandenrahmen kurze Seite (A) End top rail (A)</p>	<p>D 1x</p>  <p>Bandenrahmen kurze Seite (B) End top rail (B)</p>
<p>E 2x</p>  <p>Lange Seitenverbindung Long apron</p>	<p>F 1x</p>  <p>Kurze Seitenverbindung (A) End apron (A)</p>
<p>G 1x</p>  <p>Kurze Seitenverbindung (B) End apron (B)</p>	<p>H 2x</p>  <p>Querstrebe Cross Member</p>
<p>I 2x</p>  <p>Mittlere Querstrebe Mid Cross Member</p>	<p>J 2x</p>  <p>Langes Rahmenteil Long frame</p>
<p>K 2x</p>  <p>Bein Leg</p>	<p>L 2x</p>  <p>Ballrücklauf (A) Ball storage panel A</p>
<p>M 1x</p>  <p>Ballrücklauf (B) Ball storage panel B</p>	<p>N 1x</p>  <p>Ballrücklauf (C) Ball storage panel C</p>

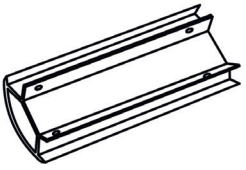
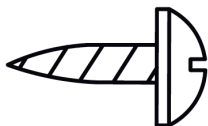
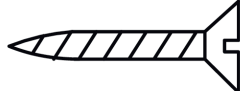
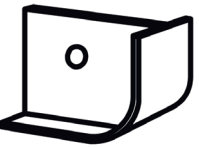
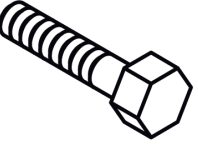
Bauteile 2 / Parts list 2:

<p>1 4x</p>  <p>Höhenverstellbarer Fuß Leg leveler</p>	<p>2 8x</p>  <p>Schraube M10x4-1/2" Bolt</p>	<p>3 24x</p>  <p>Unterlegscheibe 3/8"x25 mm washer</p>	<p>4 8x</p>  <p>Mutter M 10 mm nut</p>
<p>5 8x</p>  <p>Schraube M10 x 180 mm bolt</p>	<p>6 8x</p>  <p>Bolzen 3/8" nut</p>	<p>7 12x</p>  <p>Schraube #12*2-1/2" Screw</p>	<p>8 30x</p>  <p>Schraube 5/16" x 1-3/4" bolt</p>
<p>9 12x</p>  <p>Unterlegscheibe 5/16" x 23 mm Washer</p>	<p>10 18x</p>  <p>Unterlegscheibe 5/16" x 35 mm Washer</p>	<p>11 8x</p>  <p>Schraube 1/4" x 1" Bolt</p>	<p>12 8x</p>  <p>Unterlegscheibe 1/4" x 32 mm Washer</p>
<p>13 4x</p>  <p>Eckverbindung Top corner</p>	<p>14 8x</p>  <p>Schraube 1/4" x 1-3/4" Bolt</p>	<p>15 12x</p>  <p>Unterlegscheibe 1/4" 19 mm Washer</p>	<p>16 18x</p>  <p>Nagel Nail</p>
<p>17 6x</p>  <p>Ballfangtasche Plastic pocket</p>	<p>18 4x</p>  <p>Verblendung Ecke Apron corner</p>	<p>19 16x</p>  <p>Schraube T4 x 12mm Screw</p>	<p>20 2x</p>  <p>Schraube F4*1" Screw</p>
<p>21 2x</p>  <p>Verblendung Ecke Rail Corner</p>	<p>22 4x</p>  <p>Schraube 1/4" x 1-1/2" Bolt</p>	<p>22 1x</p>  <p>Schraubenschlüssel Wrench9</p>	

Schritt 1

step 1

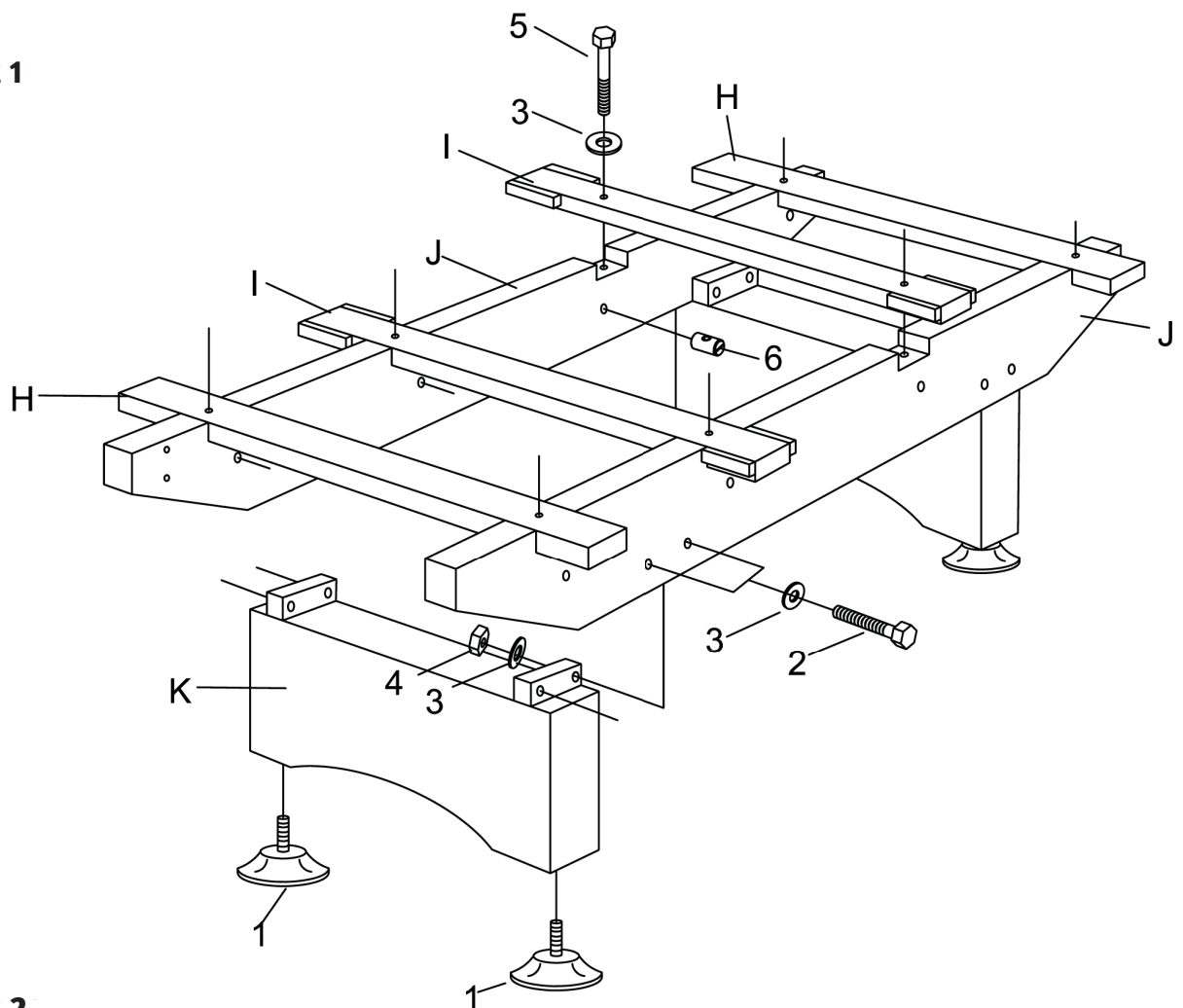

Schritt 2

step 2

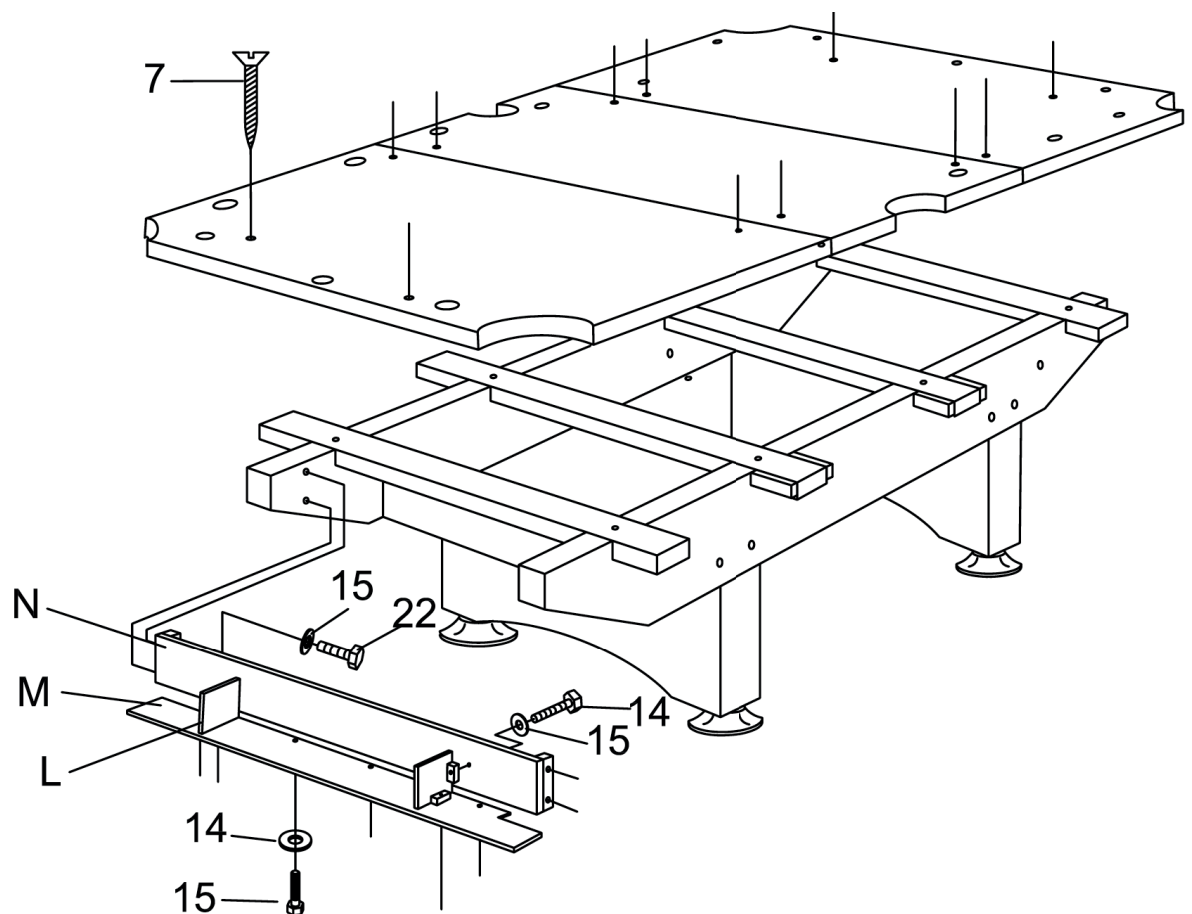

Schritt 3

step 3

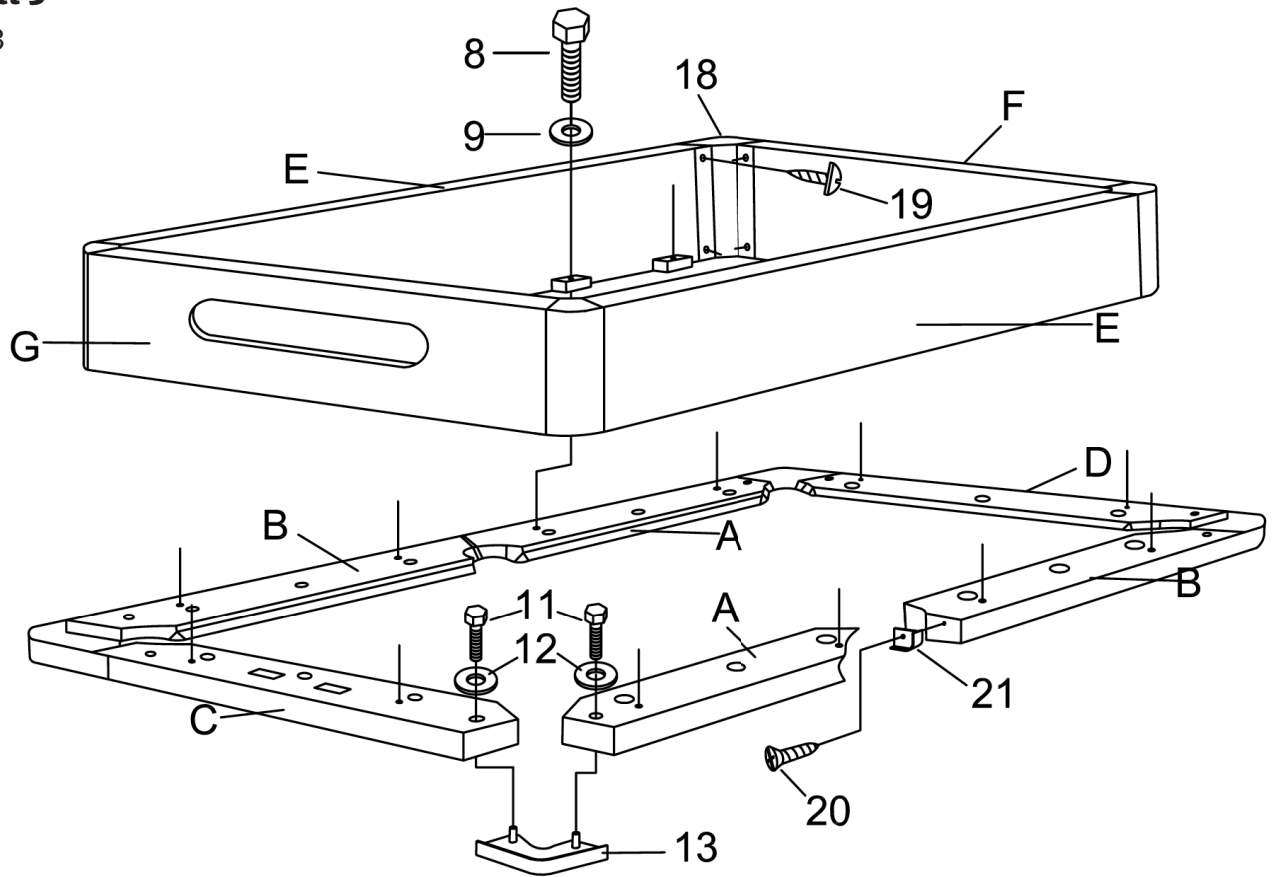

Schritt 4

step 4

