









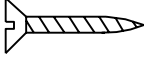
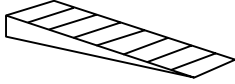
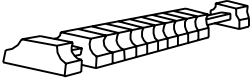

# TISCHKICKER „JUNIOR“

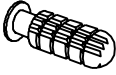
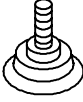
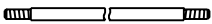
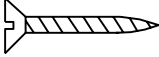
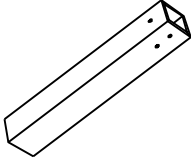
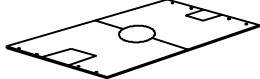

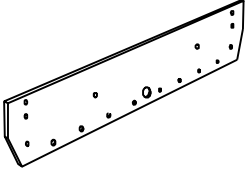
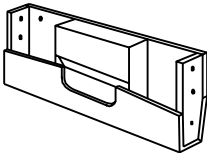
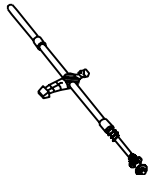
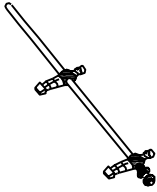
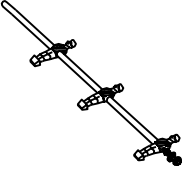
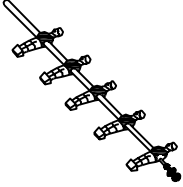
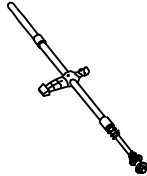
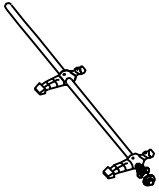
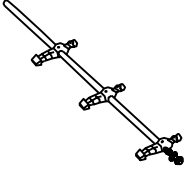
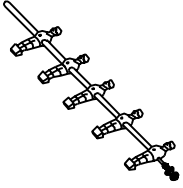
Art.-Nr.: 3530809

# Bauteile

<p>#1</p>  <p>Schraube 16 Stück</p>	<p>#2</p>  <p>Unterlegscheibe 20 Stück</p>	<p>#3</p>  <p>Schraube 8 Stück</p>	<p>#4</p>  <p>Keil 4 Stück</p>
<p>#5</p>  <p>Torzählwerk 2 Stück</p>	<p>#6</p>  <p>Mutter 4 Stück</p>	<p>#7</p>  <p>Kickergriff 8 Stück</p>	<p>#8</p>  <p>Höhenverstellbarer Fuß 4 Stück</p>
<p>#9</p>  <p>Stange 2 Stück</p>	<p>#10</p>  <p>Schraube 4 Stück</p>	<p>#11</p>  <p>Bein 4 Stück</p>	<p>#12</p>  <p>Spielfeld 1 Stück</p>
<p>#13</p>  <p>Stangenführung 2 Stück</p>	<p>#14</p>  <p>Lange Seitenverblendung 2 Stück</p>	<p>#15</p>  <p>Kurze Seitenverblendung 2 Stück</p>	<p>#16</p>  <p>Stange für einen Spieler Team A 1 Stück</p>
<p>#17</p>  <p>Stange für zwei Spieler Team A 1 Stück</p>	<p>#18</p>  <p>Stange für drei Spieler Team A 1 Stück</p>	<p>#19</p>  <p>Stange für fünf Spieler Team A 1 Stück</p>	<p>#20</p>  <p>Stange für einen Spieler Team B 1 Stück</p>
<p>#21</p>  <p>Stange für zwei Spieler Team B 1 Stück</p>	<p>#22</p>  <p>Stange für drei Spieler Team B 1 Stück</p>	<p>#23</p>  <p>Stange für fünf Spieler Team B 1 Stück</p>	<p>#24</p>  <p>Stelling 8 Stück</p>

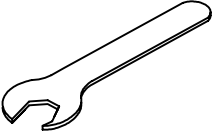
<p>#25</p>  <p>Unterlegscheibe 8 Stück</p>	<p>#26</p>  <p>Kickerball 4 Stück</p>	<p>#27</p>  <p>Sechskantschlüssel 1 Stück</p>	<p>#28</p>  <p>Maulschlüssel 2 Stück</p>
---	--	---	---

## Aufbauanleitung

Schritt 1:

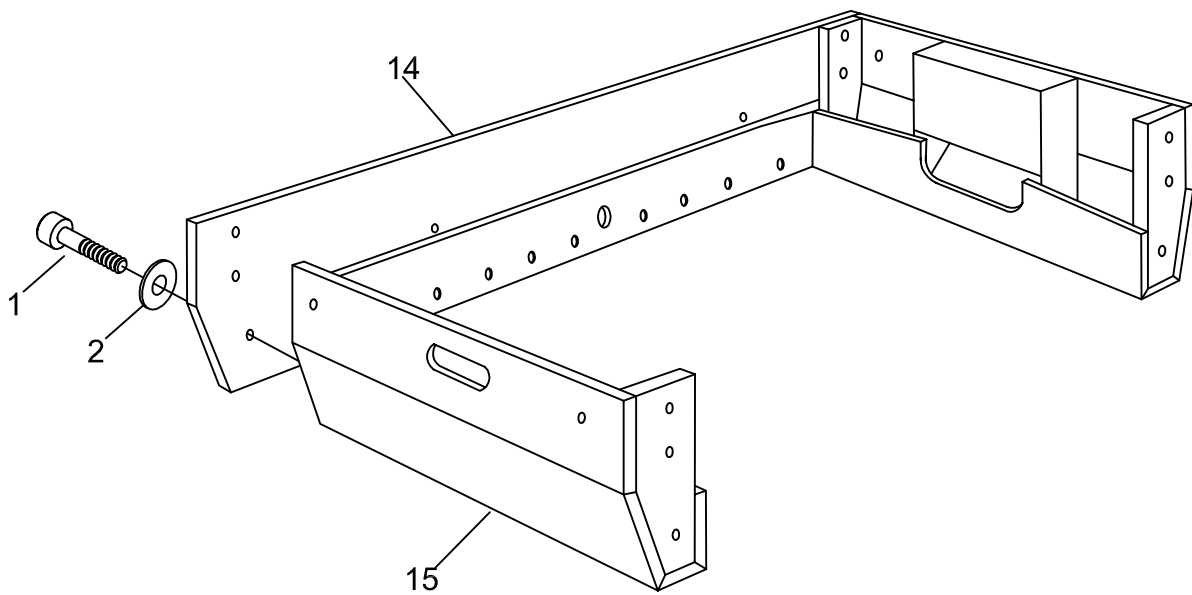

Schritt 2:

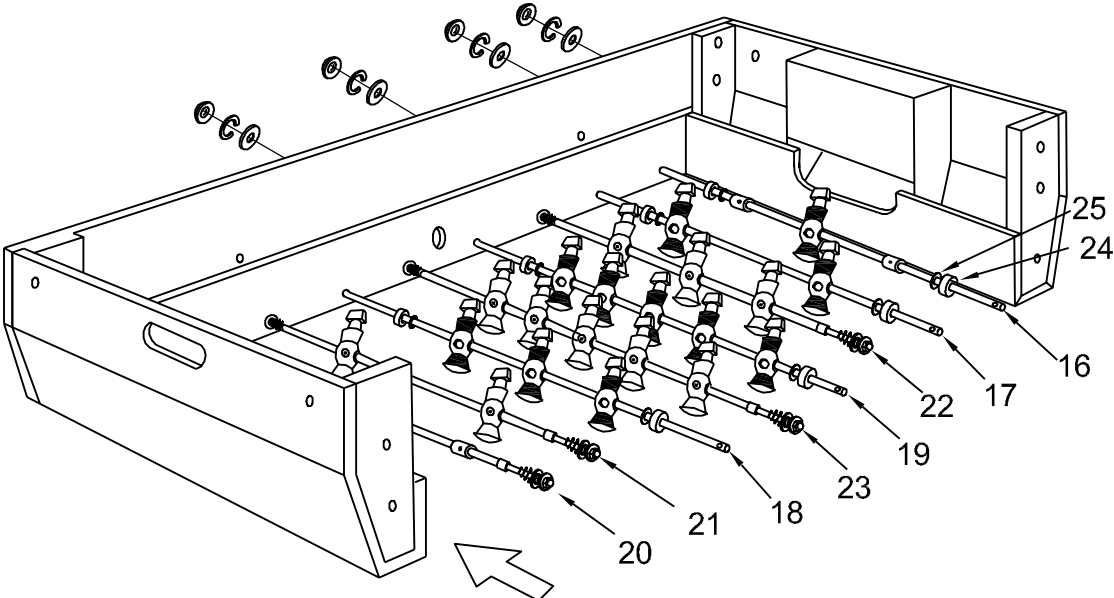

Schritt 3:

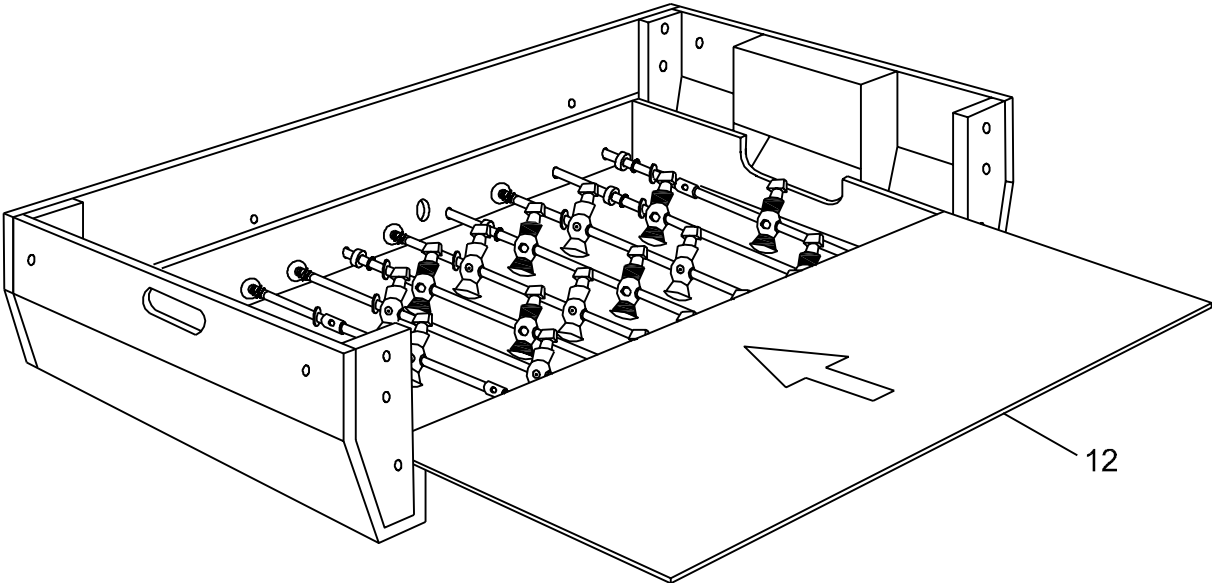

Schritt 4:

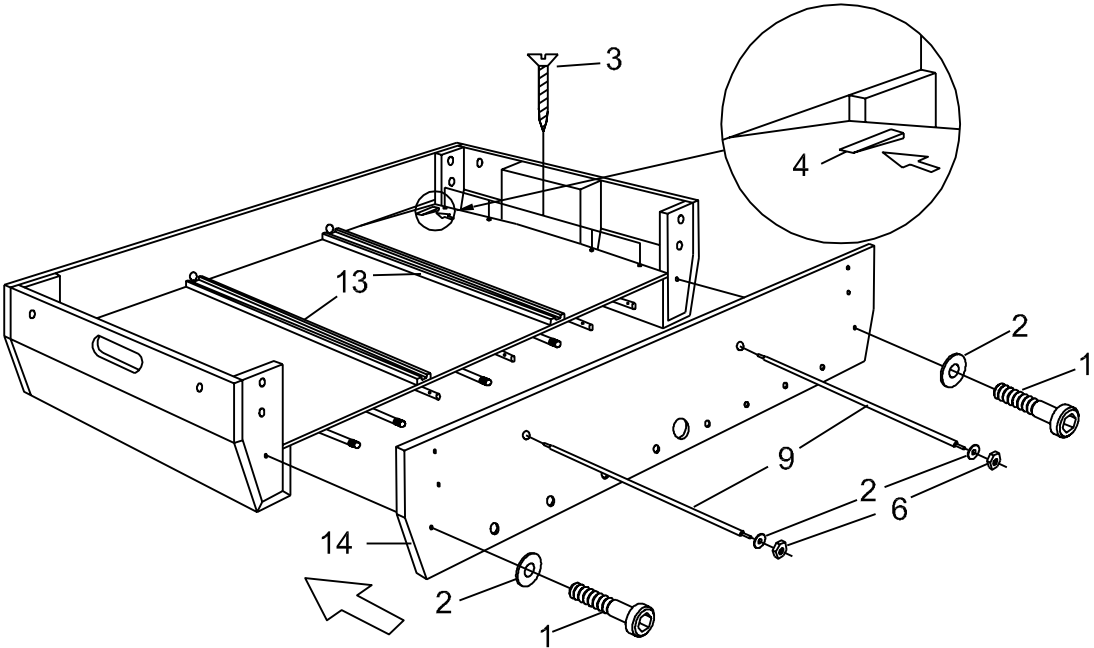

Schritt 5:

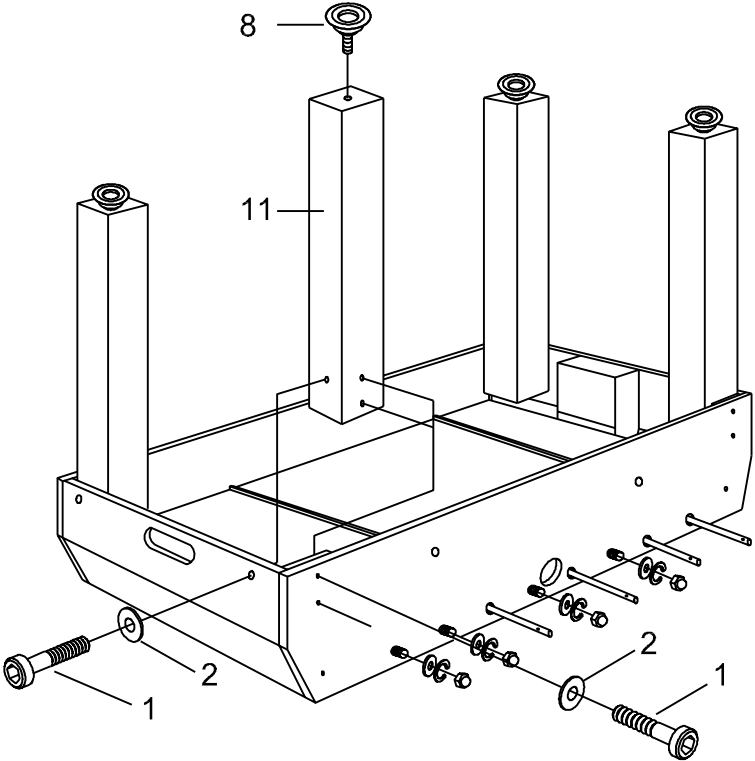

Schritt 6:

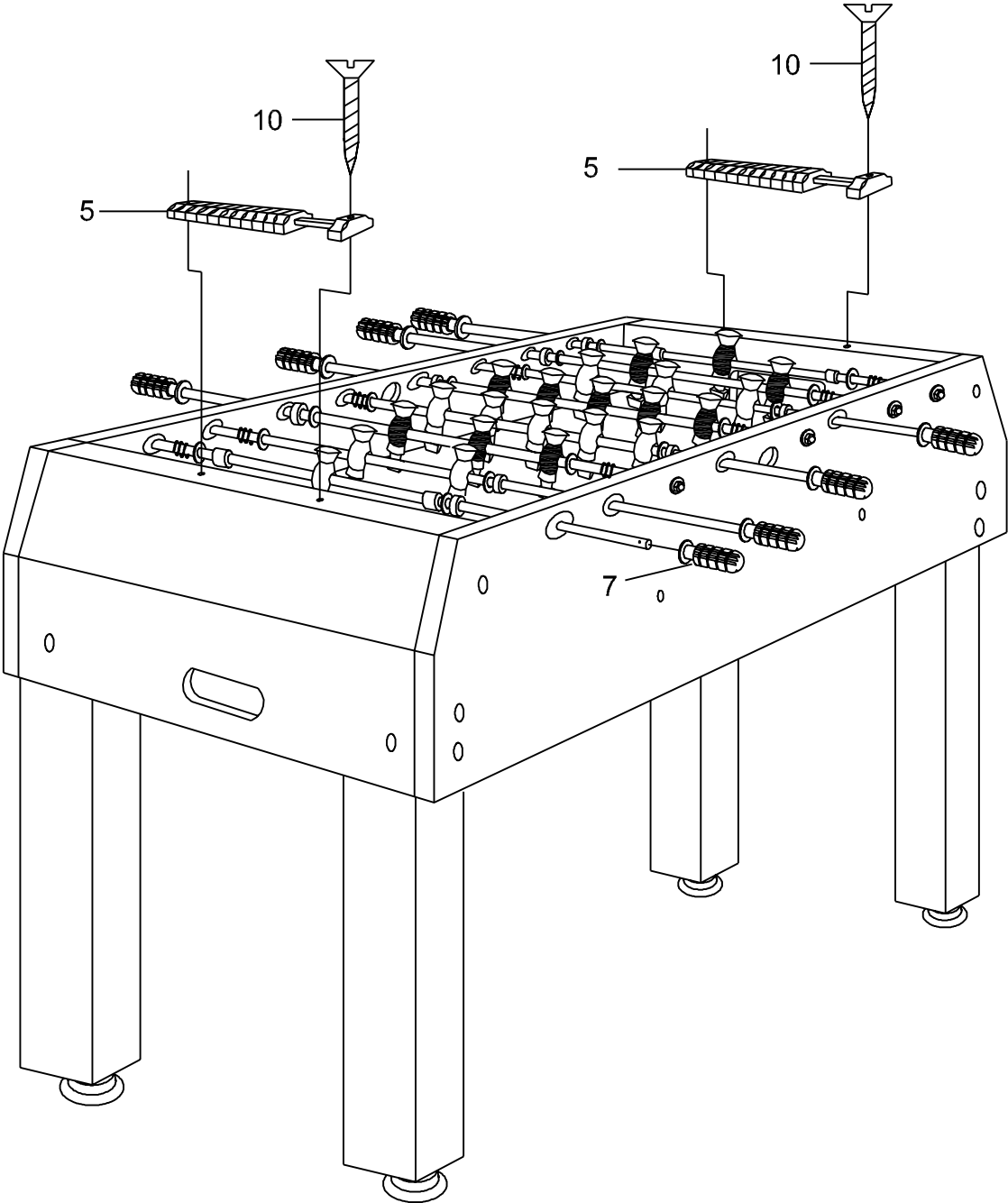







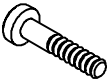

# SOCCER TABLE “JUNIOR”

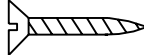
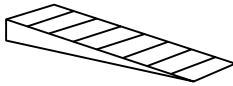
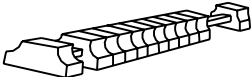

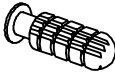
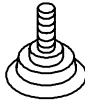
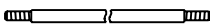
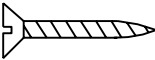
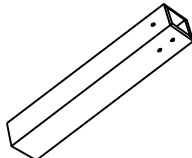
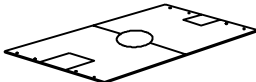

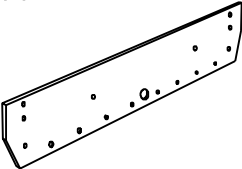
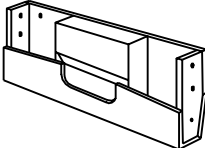
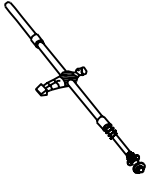
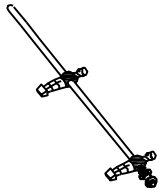
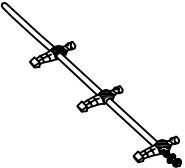
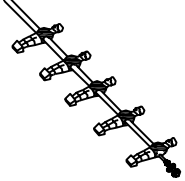
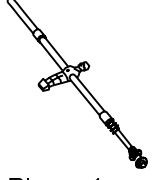
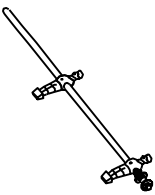
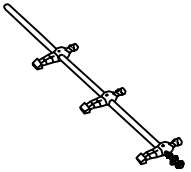
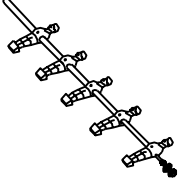
Item-No.: 3530809

Parts List

<p>#1</p>  <p>1/4"X1-1/2" Bolt 16 pieces</p>	<p>#2</p>  <p>1/4" Washer 20 pieces</p>	<p>#3</p>  <p>F3X5/8" Screw 8 pieces</p>	<p>#4</p>  <p>Triangle insert 4 pieces</p>
<p>#5</p>  <p>Scoring system 2 pieces</p>	<p>#6</p>  <p>1/4" Nut 4 pieces</p>	<p>#7</p>  <p>Handle 8 pieces</p>	<p>#8</p>  <p>Leg leveler 4 pieces</p>
<p>#9</p>  <p>1/4" Support rod 2 pieces</p>	<p>#10</p>  <p>F4X1-1/8" Screw 4 pieces</p>	<p>#11</p>  <p>Leg 4 pieces</p>	<p>#12</p>  <p>Playing surface 1 piece</p>
<p>#13</p>  <p>Playing Support Brace 2 pieces</p>	<p>#14</p>  <p>Long apron 2 pieces</p>	<p>#15</p>  <p>End apron 2 pieces</p>	<p>#16</p>  <p>Home Player 1-man rod 1 piece</p>
<p>#17</p>  <p>Home Player 2-man rod 1 piece</p>	<p>#18</p>  <p>Home Player 3-man rod 1 piece</p>	<p>#19</p>  <p>Home Player 5-man rod 1 piece</p>	<p>#20</p>  <p>Visiting Player 1-man rod 1 piece</p>
<p>#21</p>  <p>Visiting Player 2-man rod 1 piece</p>	<p>#22</p>  <p>Visiting Player 3-man rod 1 piece</p>	<p>#23</p>  <p>Visiting Player 5-man rod 1 piece</p>	<p>#24</p>  <p>Rubber rod bushing 8 pieces</p>

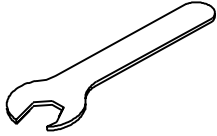

<p>#25</p>  <p>Plastic washer 8 pieces</p>	<p>#26</p>  <p>Soccer Ball 4 pieces</p>	<p>#27</p>  <p>Allen Key 1 piece</p>	<p>#28</p>  <p>Wrench 2 pieces</p>
---	--	--	---

Step 1:

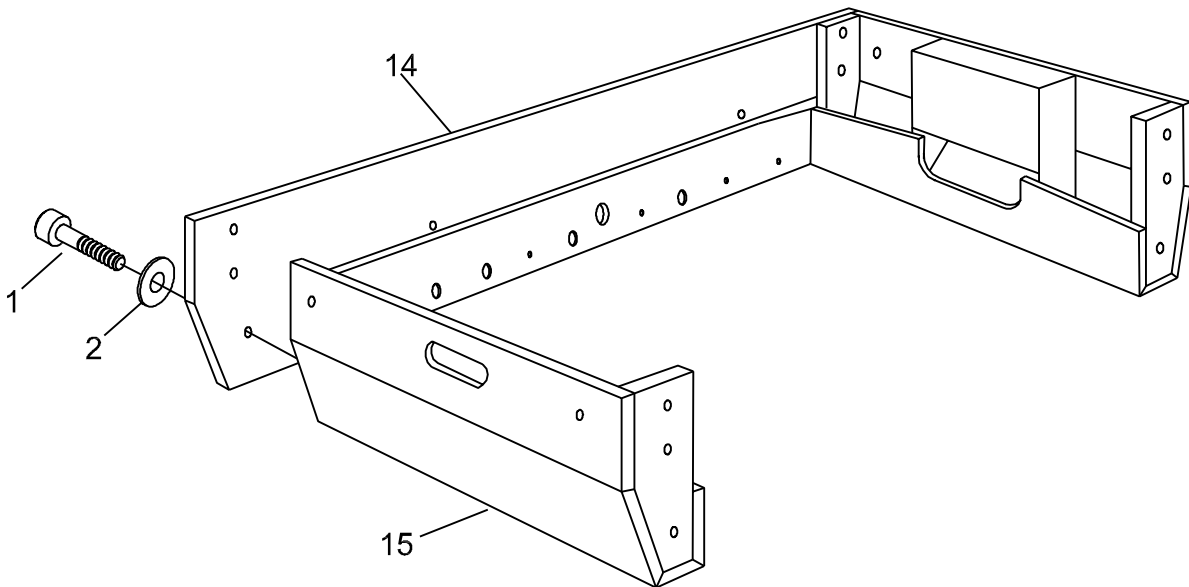

Step 2:

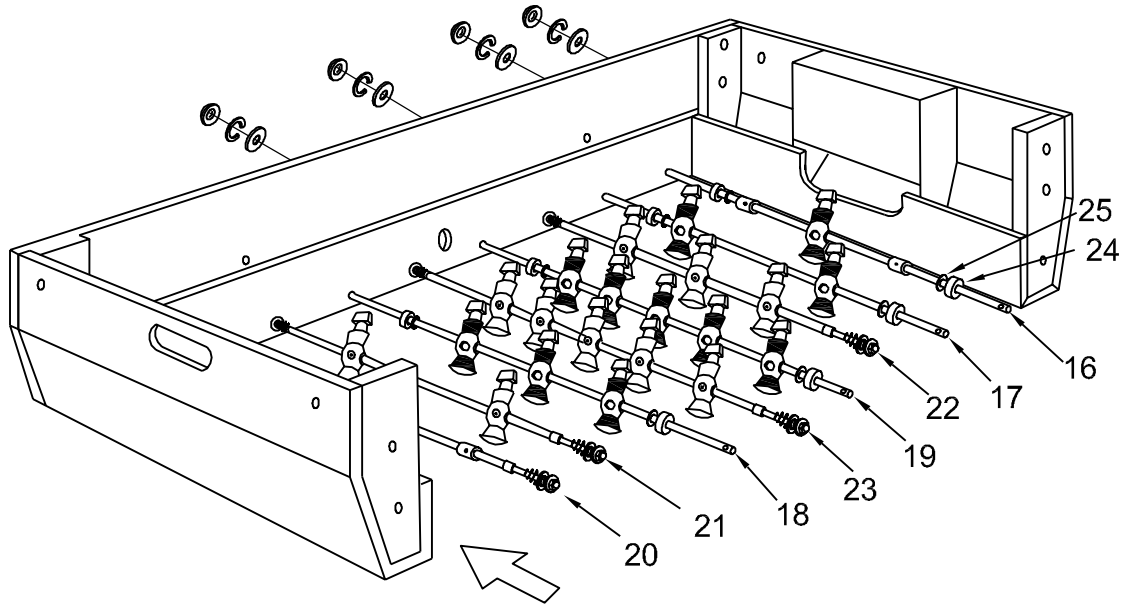

Step 3:

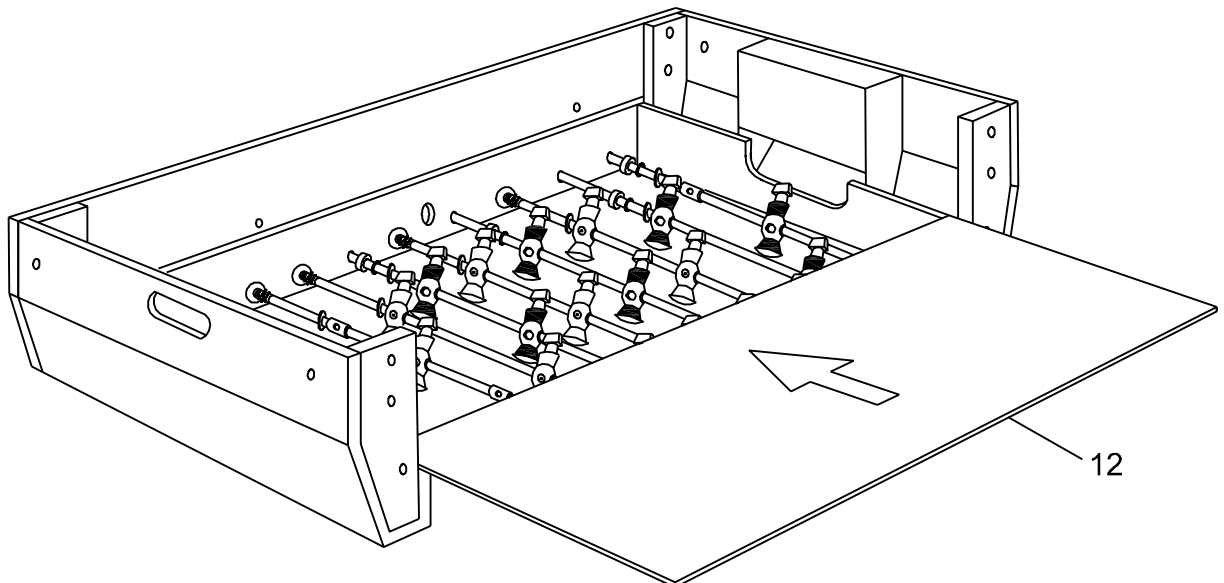

Step 4:

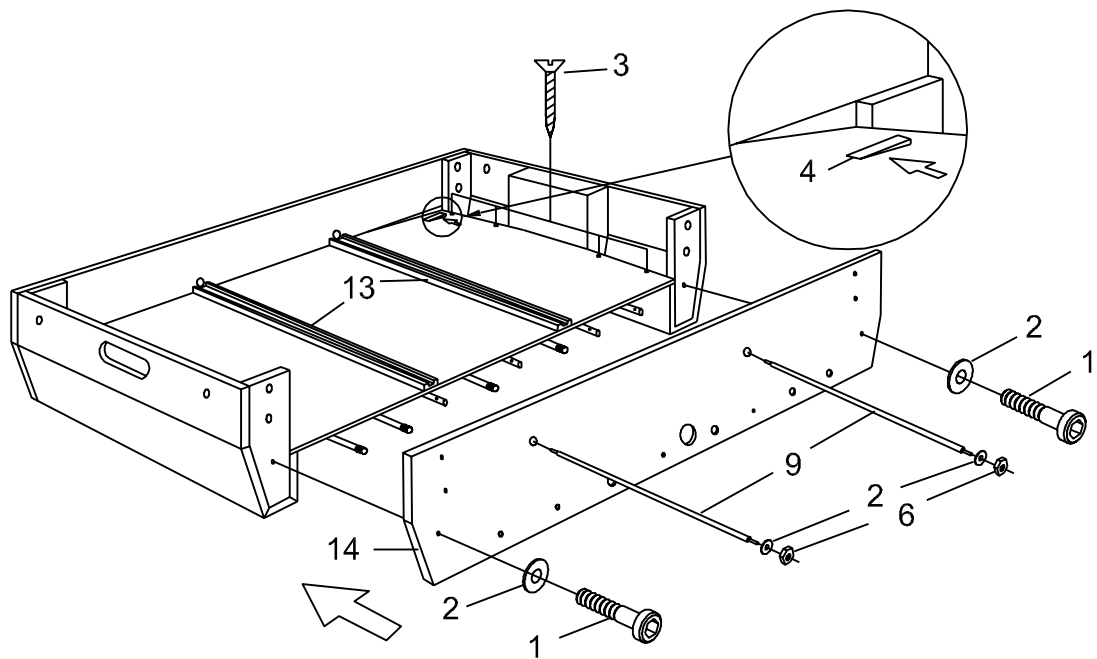

Step 5:

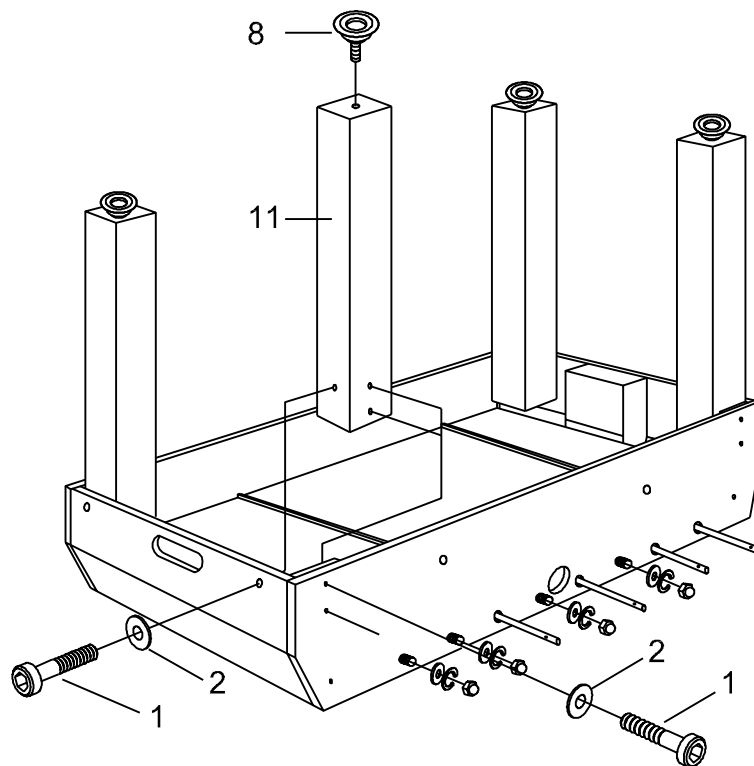

Step 6:

