

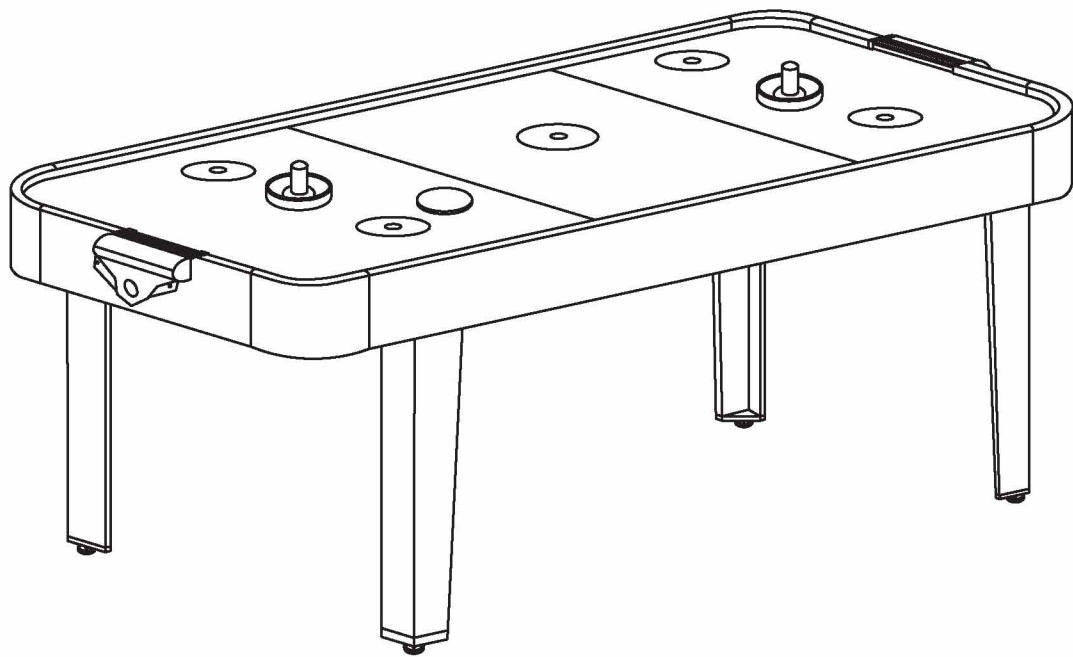

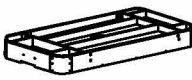







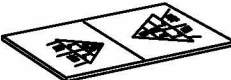









# ASSEMBLY INSTRUCTION

ITEM#:AUT-9505

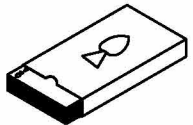

# Part List

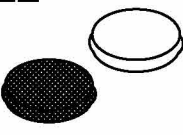
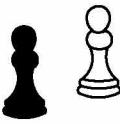
<p><b>#1</b></p>  <p>Cabinet 1 pc</p>	<p><b>#2</b></p>  <p>Cabinet 1 pc</p>	<p><b>#3</b></p>  <p>1 pcS</p>	<p><b>#4</b></p>  <p>Legs 4 pcs</p>	<p><b>#5</b></p>  <p>LEG LEVELER 4PCS</p>
<p><b>#6</b></p>  <p>1/4" BLACK FLAT WASHER 16PCS</p>	<p><b>#7</b></p>  <p>1/4X1-1/8" BOLT 16PCS</p>	<p><b>#8</b></p>  <p>T3.5X12mm SCREW 4 PCS</p>	<p><b>#9</b></p>  <p>Shaking cup 1 pc</p>	<p><b>#10</b></p>  <p>Wrench 1 pcs</p>
<p><b>#11</b></p>  <p>Ball Collectors 2 pcs</p>	<p><b>#12</b></p>  <p>Table tennis rackets 2 pcs</p>	<p><b>#13</b></p>  <p>Table tennis Balls 2 pcs</p>	<p><b>#14</b></p>  <p>Table tennis net 1 pc</p>	<p><b>#15</b></p>  <p>2 pcs</p>
<p><b>#16</b></p>  <p>Goalers 2 pcs</p>	<p><b>#17</b></p>  <p>Pucks 2 pcs</p>	<p><b>#18</b></p>  <p>Bowling bottles 10 pcs</p>	<p><b>#19</b></p>  <p>Shuffle balls 1 SET</p>	<p><b>#20</b></p>  <p>Play card 1 pc</p>
<p><b>#21</b></p>  <p>Dices 1 set</p>	<p><b>#22</b></p>  <p>Ancient chess game chess 30 pcs</p>	<p><b>#23</b></p>  <p>Backgammon 1 SET</p>		

STEP 1

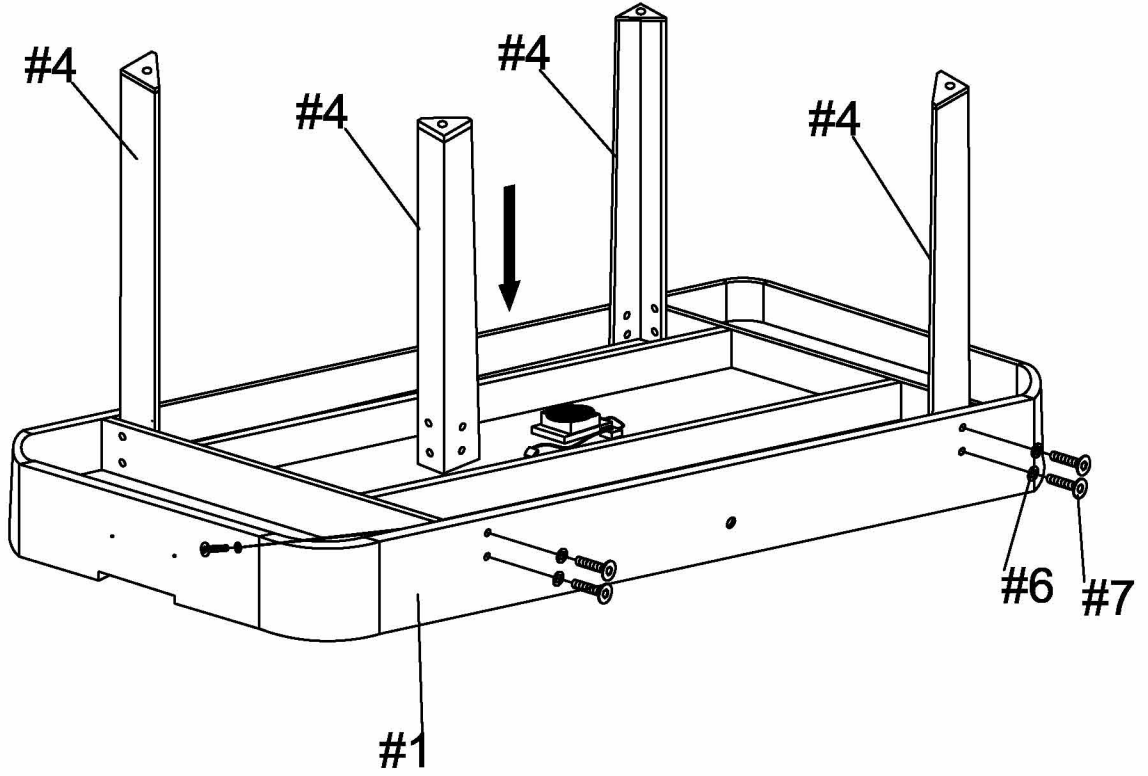

STEP 2

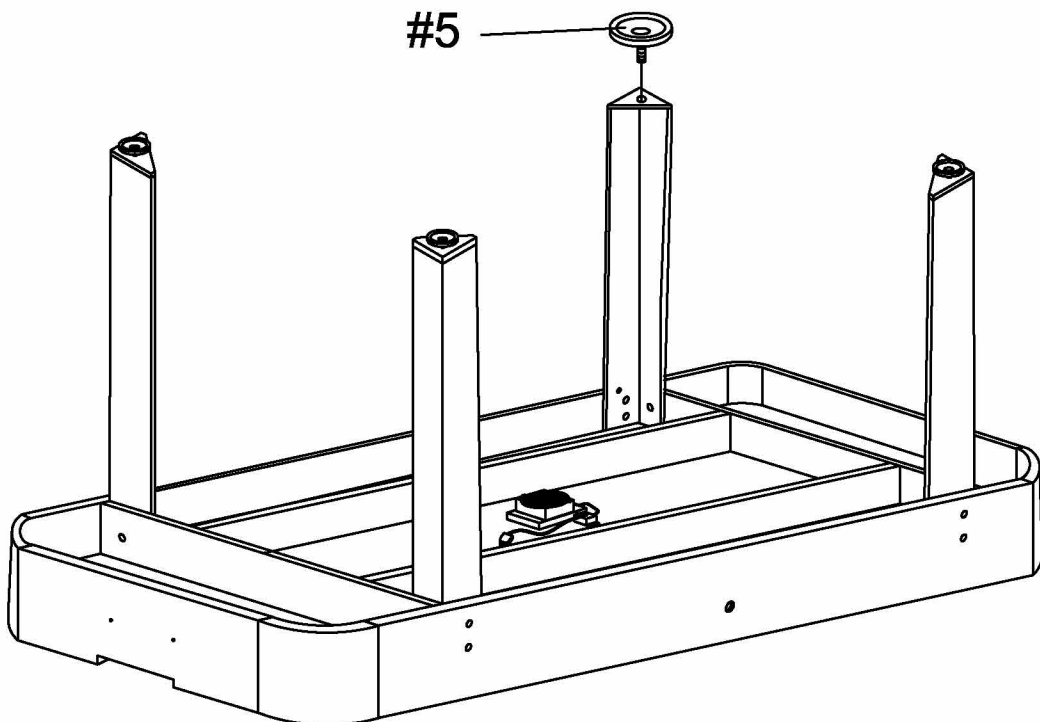

**CAUTION:** Two strong adults are recommended to turn the table over as shown.

1. Lift the table off the ground.
2. Turn the table over.
3. Place it on all four feet at the same time on the ground.

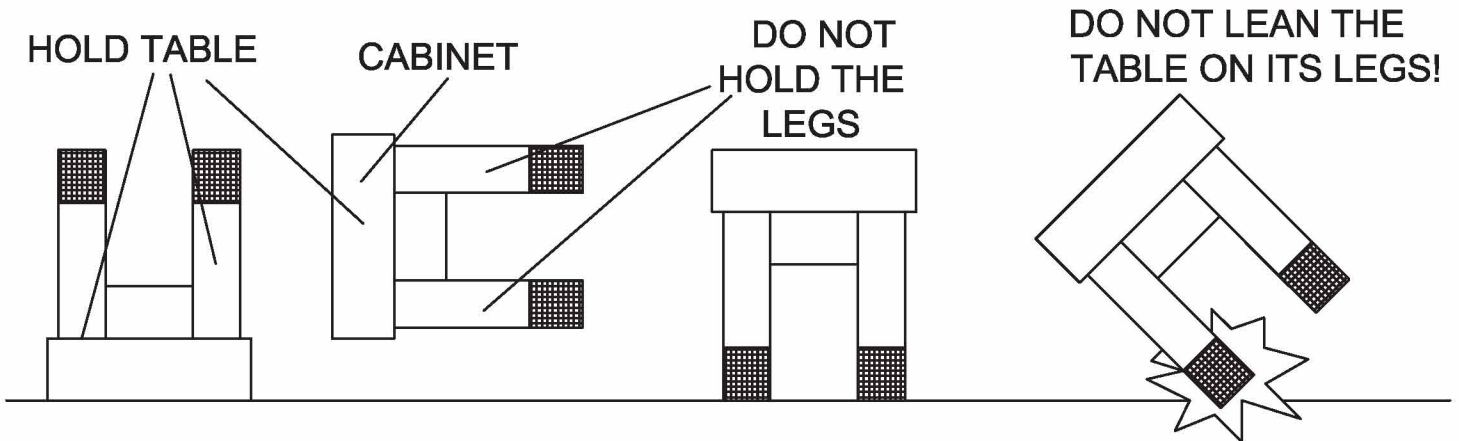

### STEP 3

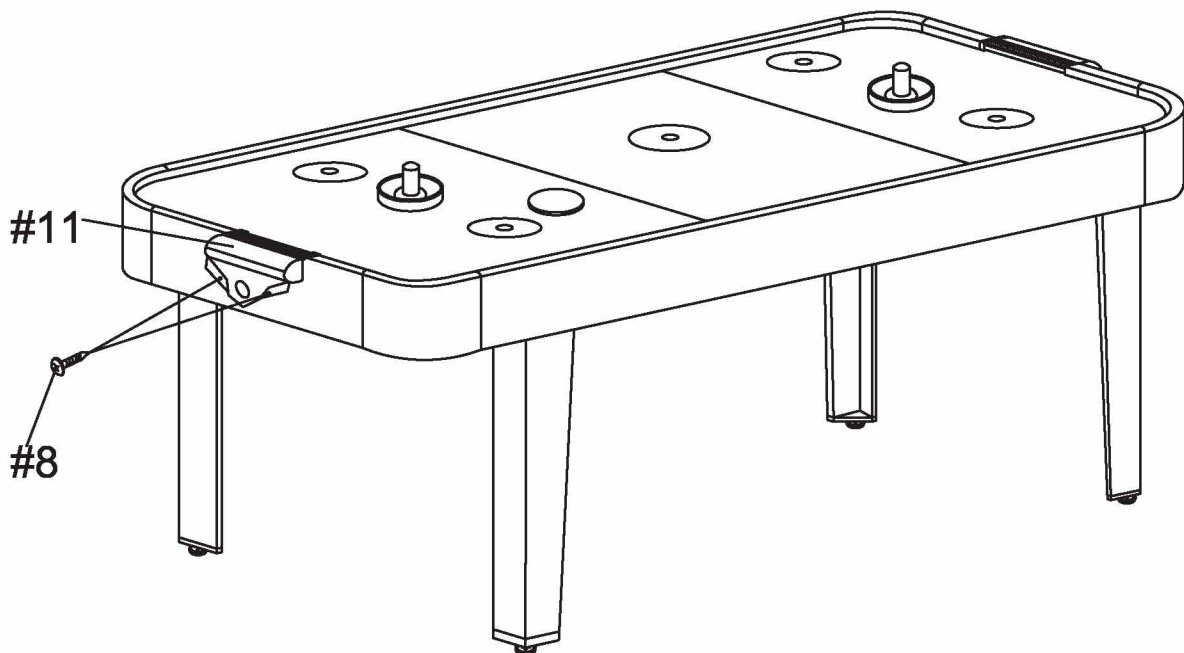

STEP 4

