

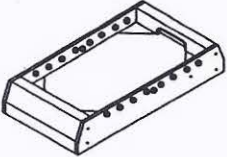









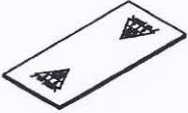

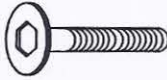



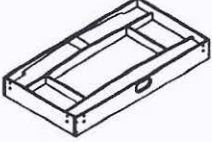

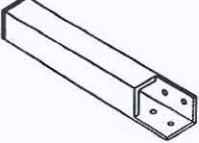
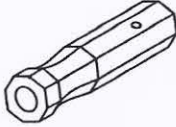

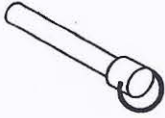
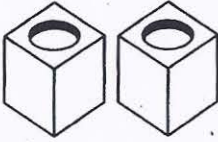
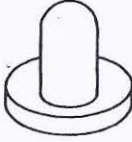
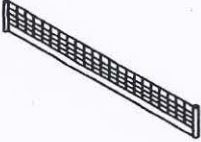
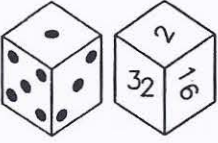
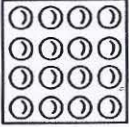
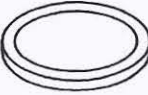
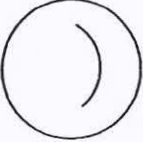



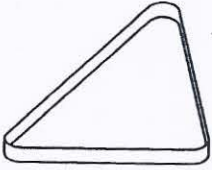
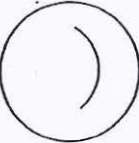
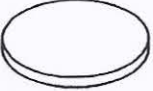

# Home Fun 9 in 1 PARTS IDENTIFIER

 <p>Soccer Table 1 pcs</p>	 <p>Home Man 11 pcs</p>	 <p>Away Man 11 pcs</p>	 <p>Stop Ring 4 pcs</p>
 <p>Bowling Table 1 pcs</p>	 <p>5 Players Rod 2 pcs</p>	 <p>3/8"x1-3/8" Bolt 16 pcs</p>	 <p>3/8" Flat Washer 16 pcs</p>
 <p>Hockey Table 1 pcs</p>	 <p>1 or 3 Players Rod 4 pcs</p>	 <p>Rubber Bushing 16 pcs</p>	 <p>Slide Scorer 2 pcs</p>
 <p>Billiard Table 1 pcs</p>	 <p>2 Players Rod 2 pcs</p>	 <p>Rubber Cap 8 pcs</p>	 <p>Soccer Ball 4 pcs</p>
 <p>Leg 4 pcs</p>	 <p>Wood Handle 8 pcs</p>	 <p>Ball Entry Cap 2 pcs</p>	 <p>Leg Leveler 4 pcs</p>

 Iron Pin 2 pcs	 Chalk 2 pcs	 Hockey Striker 2 pcs	 Table Tennis Net 1 pc
 Dice 1 set	 Billiard Ball 1 set	 Hockey Puck 2 pcs	 Table Tennis Ball 2 pcs
 5/8" Plastic Washer 16 pcs	 Cue Stick 2 pcs	 Bowling Pin 10 pcs	 Chess 1 set
 Table Tennis Paddle 2 pcs	 Triangle 1 pc	 2" Bowling Ball 1 pc	 Checkers 1 set
 Brush 1 pc	 Shuffle Punk 6 pcs	 5/8" Round Head Phillips Screw 14 pcs	 Locking Nut 26 pcs
 5/32"x1-1/8" Bolt 26 pcs	 3/16"x3/4" Flat Head Bolt 8 pcs	 Tool 1 pc	 Plastic Handle 8 pcs

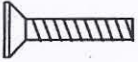
# ASSEMBLY INSTRUCTIONS

1. Place table with playing side down on flat surface.
2. Attach the legs using  $3/8"$  x  $1-3/8"$  bolts and  $3/8"$  flat washers through the side panels and the end panels.
3. Attach the leg levelers as down.
4. *CAREFULLY* Turn table to its upright position (two adults).

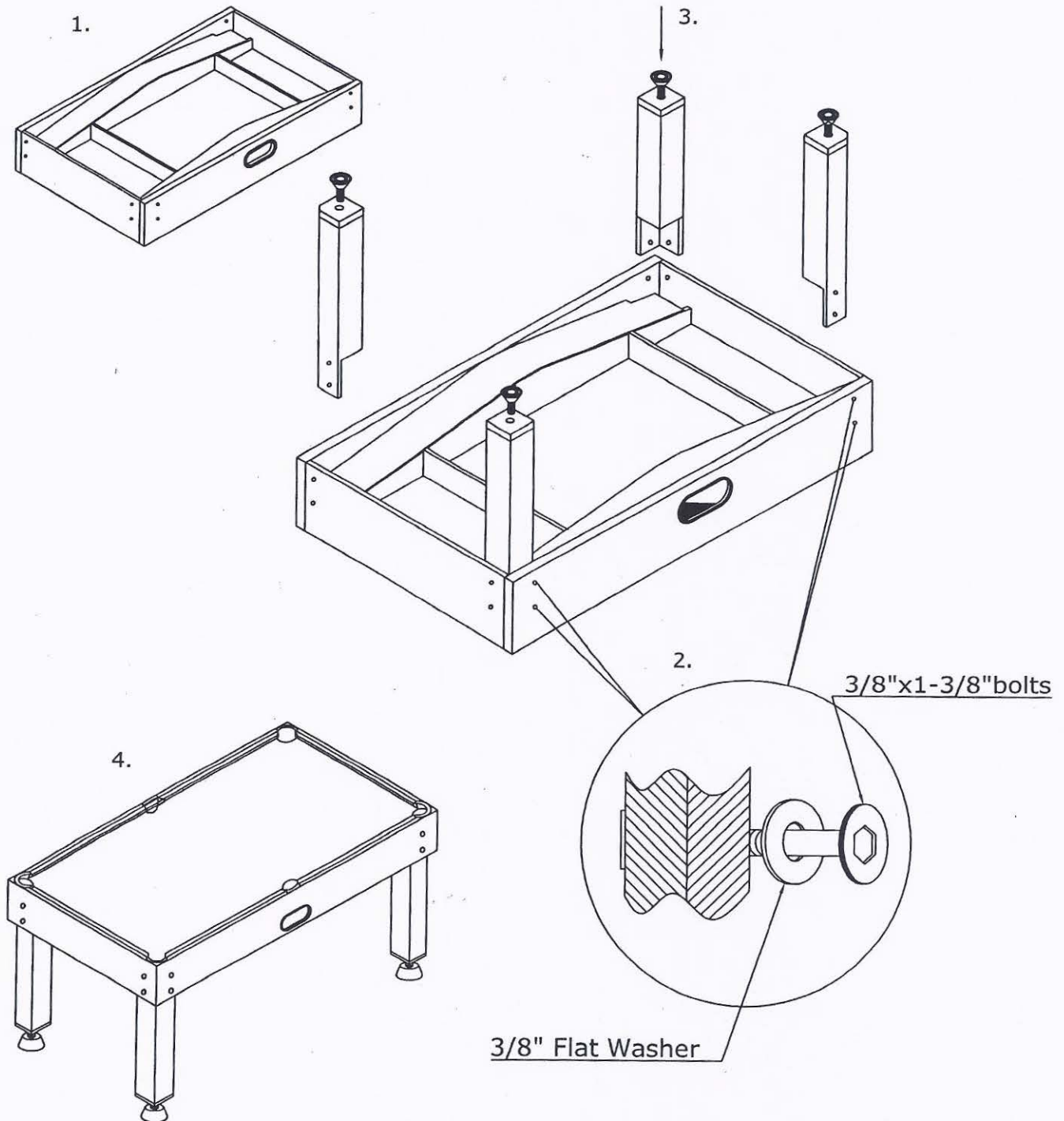



# ASSEMBLY INSTRUCTIONS

5. Place soccer table on top of assembled billiards table.

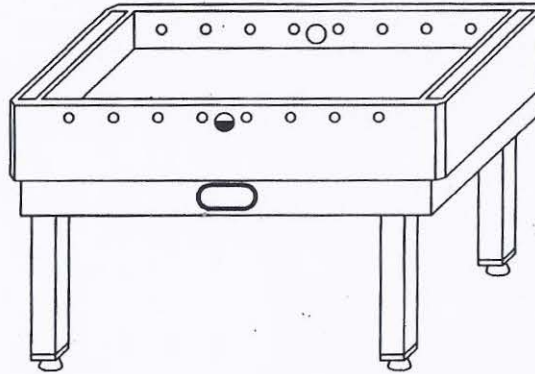

6. Attach the two black plastic ball entry cups to side panels of table with 5/8" round head phillips screws.

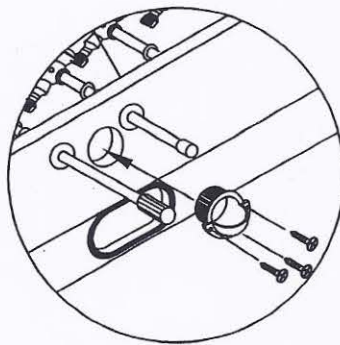

7. Attach the two sets of slide scorers and end brackets to the end of table with 5/8" round head phillips screws.

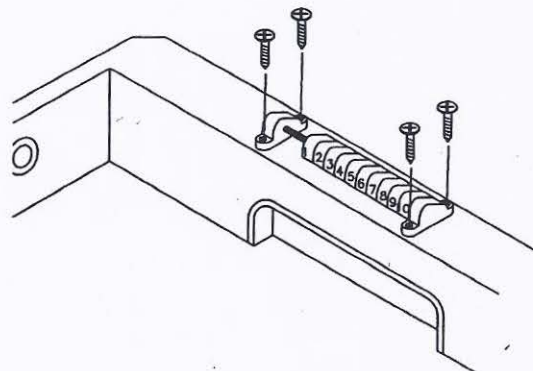

# ASSEMBLY INSTRUCTIONS

## 8. ROD ATTACHMENT

Push Wood handles onto rod ends that have a hole drilled 1/2" from the end and using 3/16"x3/4" Flat Head Bolt.

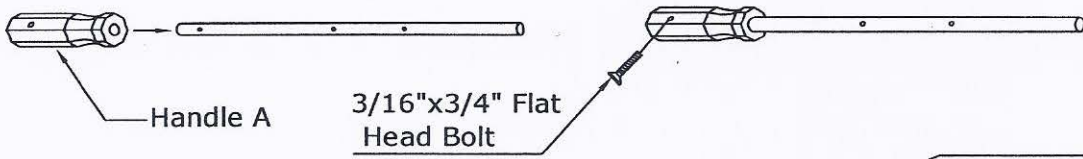

**IMPORTANT:** To prevent handles from coming off during play make sure handles are on as far as they can go, this can be done by holding the rod and tapping handle on floor. Spray rods with a glass cleaner to slide parts on easier.

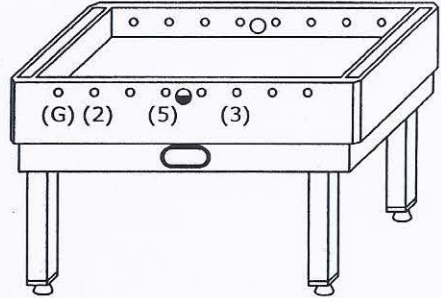

Use this diagram to identify rod order

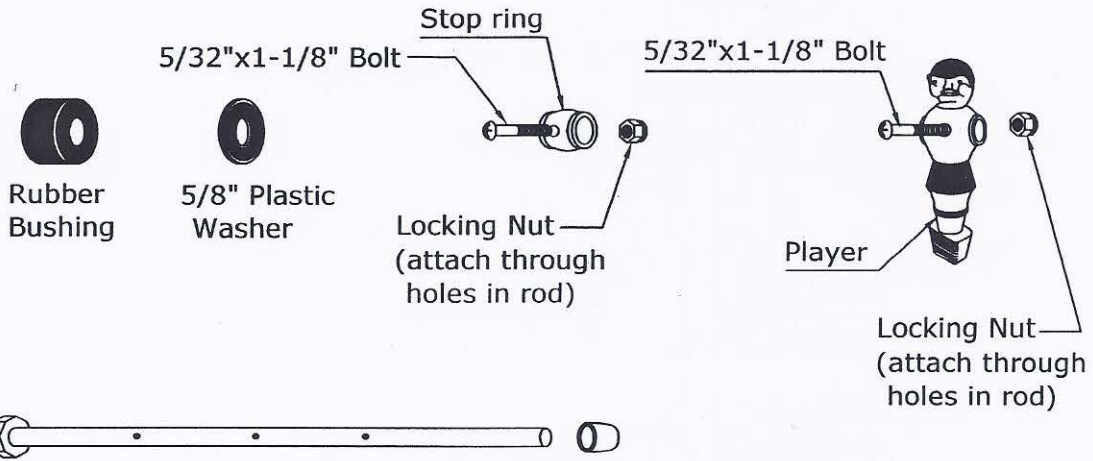

**NOTE:** Insert rod through one end panels hole only, slide on pieces and then insert through other end panel hole. Attach end caps to end of rod.

## GOALIE ROD(G)

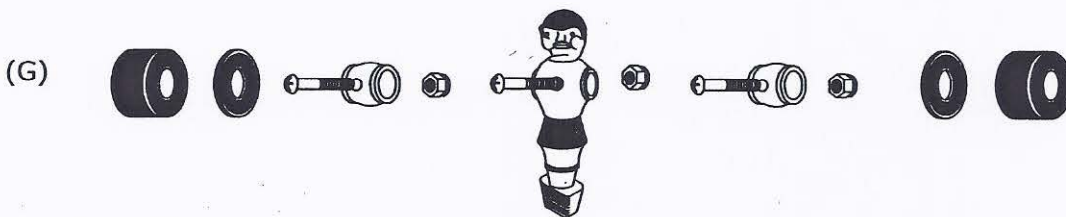

1 Player Rod (3 holes)

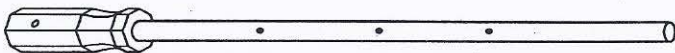

# ASSEMBLY INSTRUCTIONS

## ALL OTHER RODS

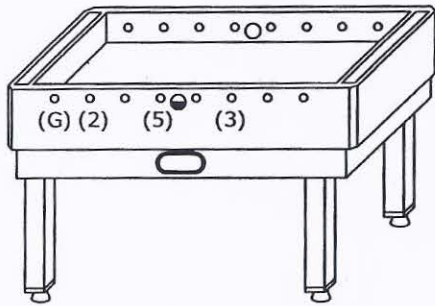

Use this diagram to identify rod order

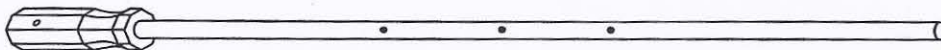
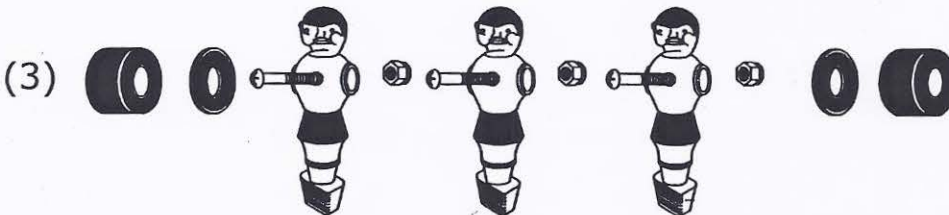
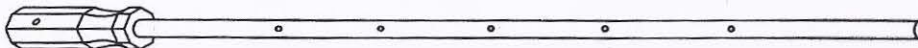
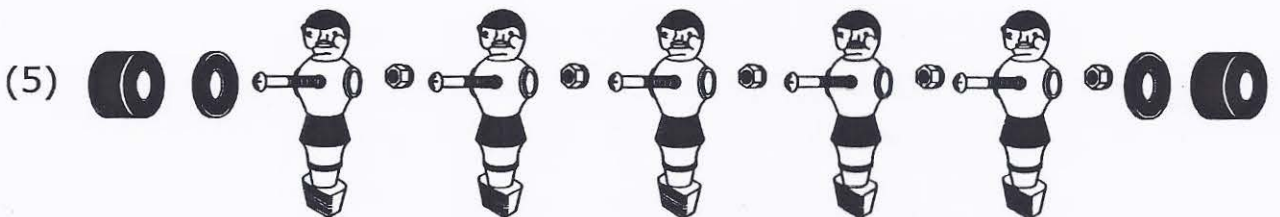
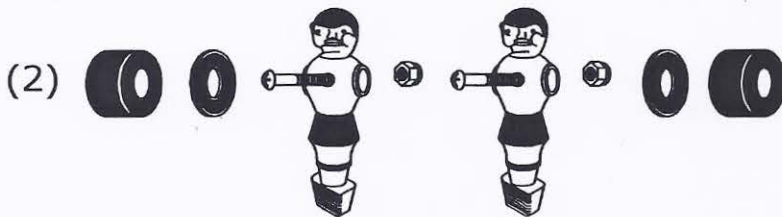

ONCE YOU HAVE COMPLETED THIS SIDE OF TABLE REPEAT THE SAME SEQUENCE OTHER SIDE OF TABLE.



# ASSEMBLY INSTRUCTIONS

9. Once soccer top is firmly in place, slide the iron pins in both sides of table as shown below. These pins must be removed before changing tops again.

