

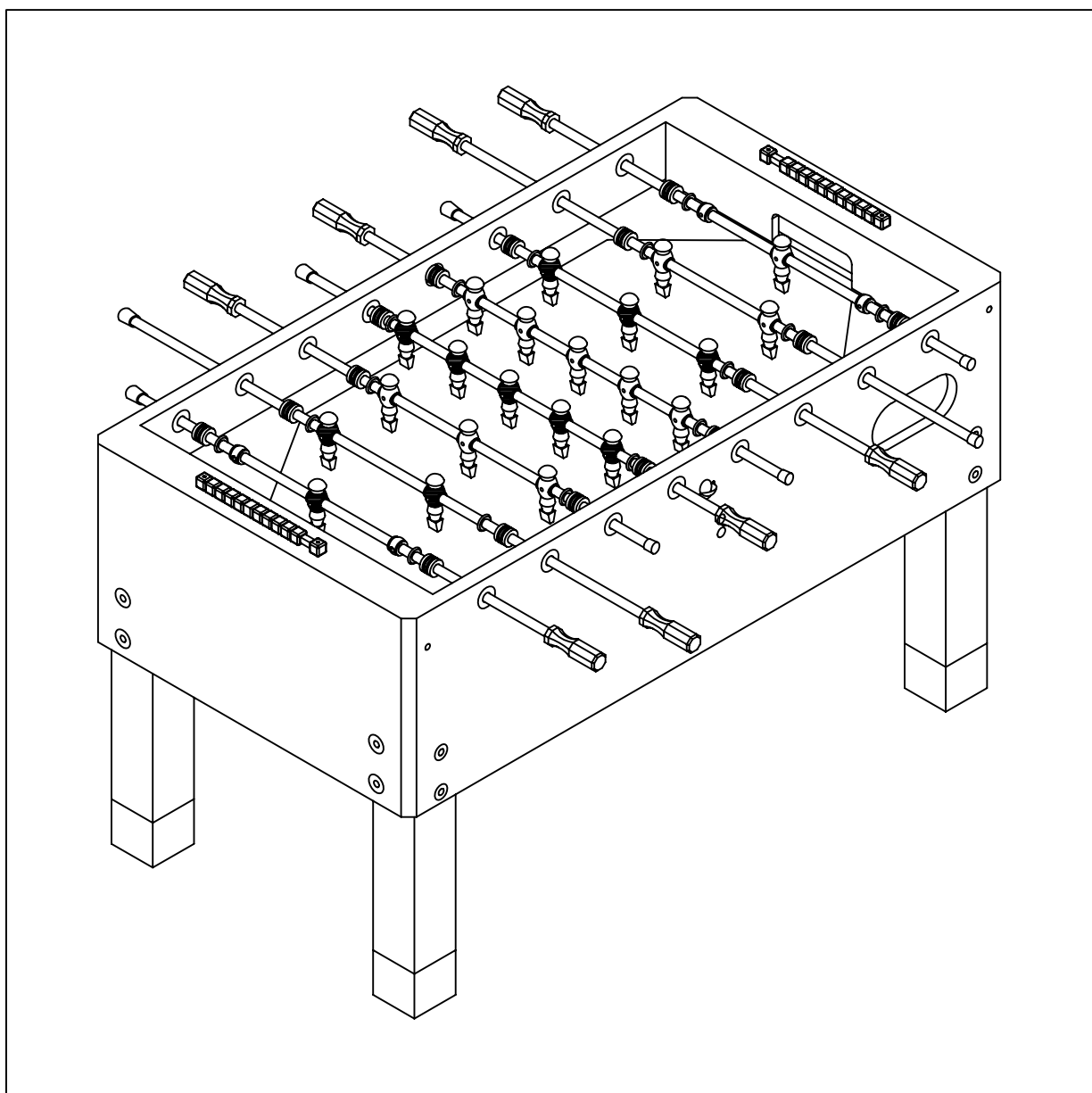

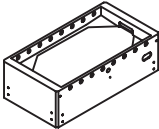

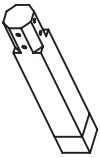

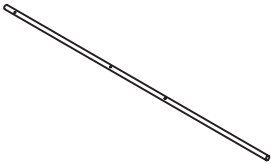

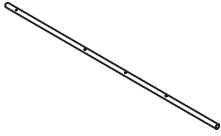
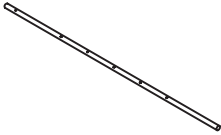

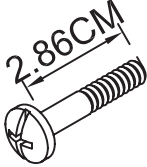



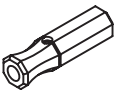



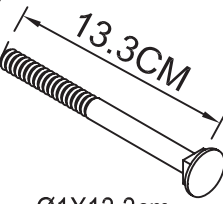
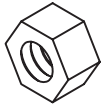
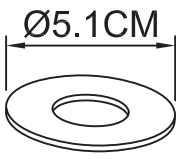

# TISCHKICKER „PROFI“

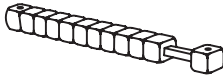

Art.-Nr.: AUT-5913

## Bauteile

<p>#1</p>  <p>Korpus 1 Stück</p>	<p>#2</p>  <p>Beine 4 Stück</p>	<p>#3</p>  <p>Kickerstange für 2 Spieler 2 Stück</p>	<p>#4</p>  <p>Kickerstange für 3 Spieler 4 Stück</p>
<p>#5</p>  <p>Kickerstange für 5 Spieler 2 Stück</p>	<p>#6</p>  <p>Figuren Team A 11 Stück</p>	<p>#7</p>  <p>Figuren Team B 11 Stück</p>	<p>#8</p>  <p>Ø0.4x2.86cm Schraube für Kickerfigur und Stelling 26 Stück</p>
<p>#9</p>  <p>Ø0.4cm Mutter für Kickerfigur und Stelling 26 Stück</p>	<p>#10</p>  <p>Ø1.6X3.6cm Unterlegscheibe 16 Stück</p>	<p>#11</p>  <p>Stangenendkappe 8 Stück</p>	<p>#12</p>  <p>Stelling 4 Stück</p>
<p>#13</p>  <p>Kickergriff 8 Stück</p>	<p>#14</p>  <p>Stangenpuffer 16 Stück</p>	<p>#15</p>  <p>Ø0.4X1.6cm Schraube für Balleinwurfschale 6 Stück</p>	<p>#16</p>  <p>Balleinwurfschale 2 Stück</p>
<p>#17</p>  <p>Ø1X13.3cm Schrauben für Unterlegscheiben 16 Stück</p>	<p>#18</p>  <p>Ø1cm Mutter für Unterlegscheiben 16 Stück</p>	<p>#19</p>  <p>Ø1.27X5.1cm Unterlegscheiben 16 Stück</p>	<p>#20</p>  <p>Ø1X2.5cm Unterlegscheiben 16 Stück</p>
<p>#21</p>  <p>Ø1cm Unterlegscheibe 16 Stück</p>	<p>#22</p>  <p>Ø0.4X5.1cm Schrauben für Torzählwerke 4 Stück</p>	<p>#23</p>  <p>Torzählwerke 2 Stück</p>	<p>#24</p>  <p>Ø0.5X1.5cm Schrauben für Kickergriffe 8 Stück</p>

<p>#25</p>  <p>Kickerbälle 4 Stück</p>	<p>#26</p>  <p>Sechskantschlüssel 1 Stück</p>	<p>#27</p>  <p>Höhenverstellbarer Fuß 4 Stück</p>	<p>#28</p>  <p>Abdeckkappe 2 Stück</p>
---	--	--	---

## Aufbauanleitung

Schritt 1:

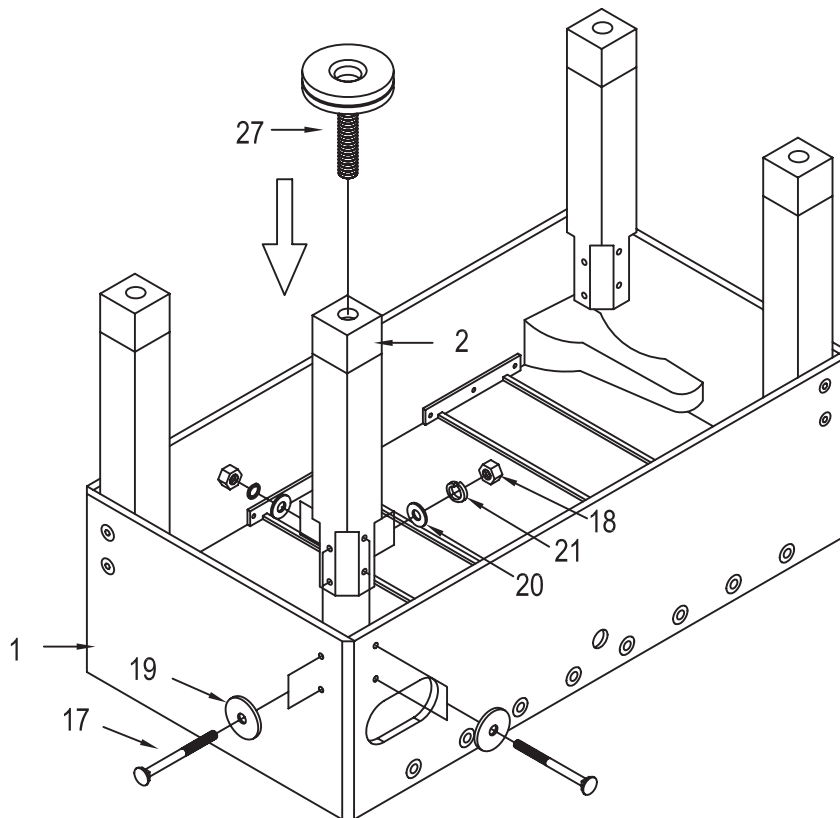

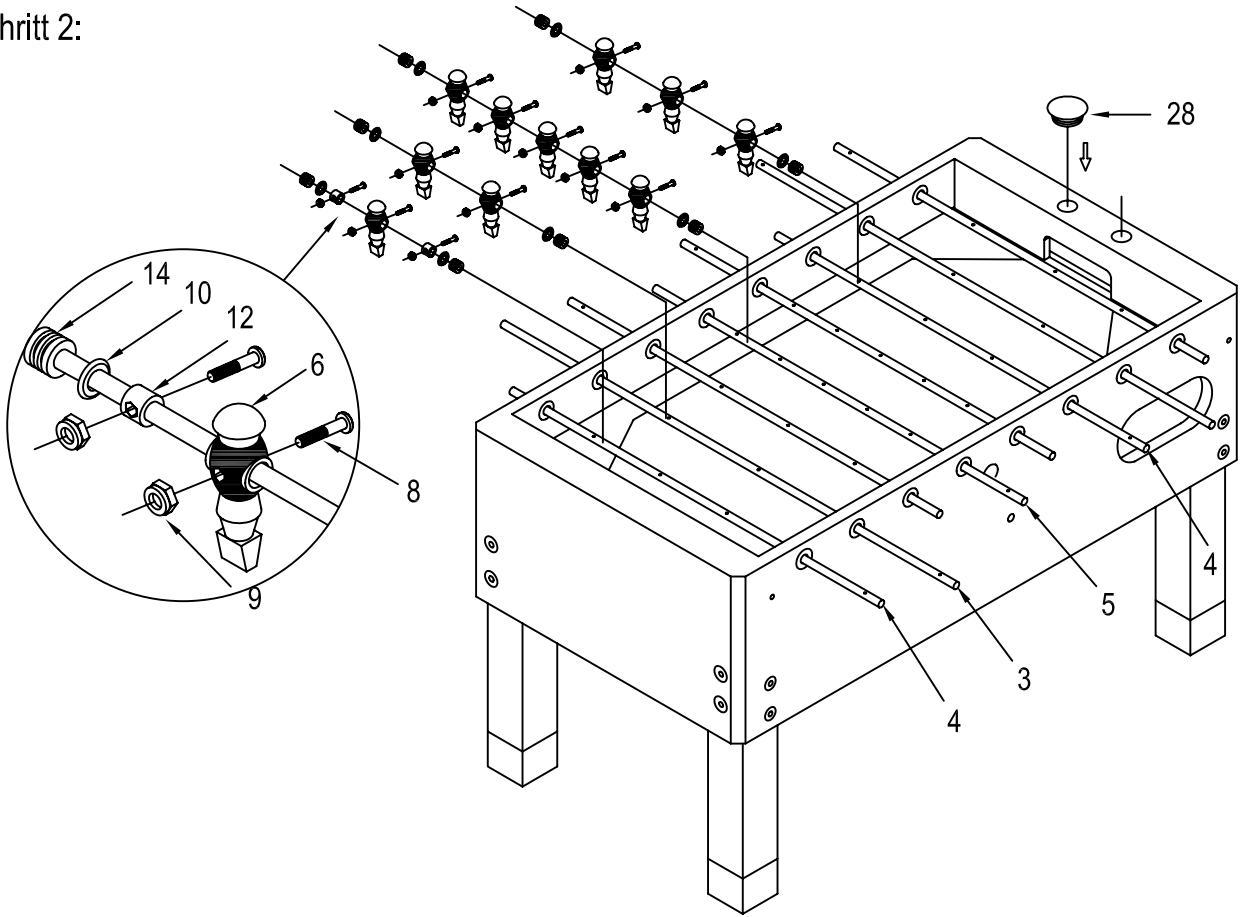

Schritt 2:

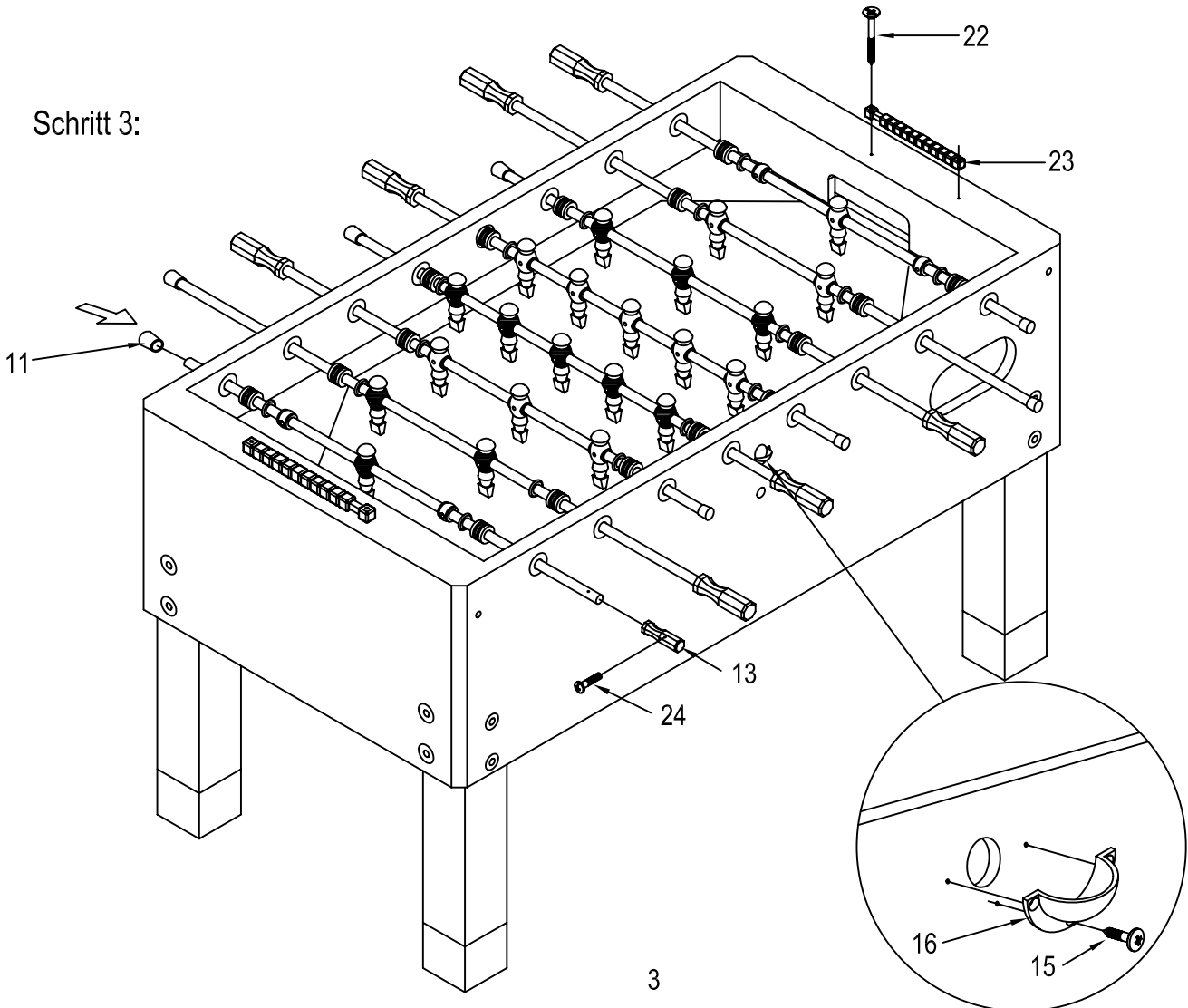

Schritt 3:

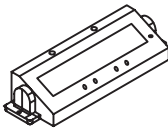
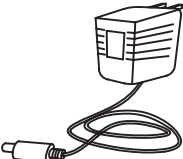

# Optional:

<p>#29</p>  <p>Score board 1 Stück</p>	<p>#30</p>  <p>Adapter 1 Stück</p>	<p>#31</p>  <p>Ø0.4X1.2cm Schrauben für Torzählwerke 2 Stück</p>
---	---	---

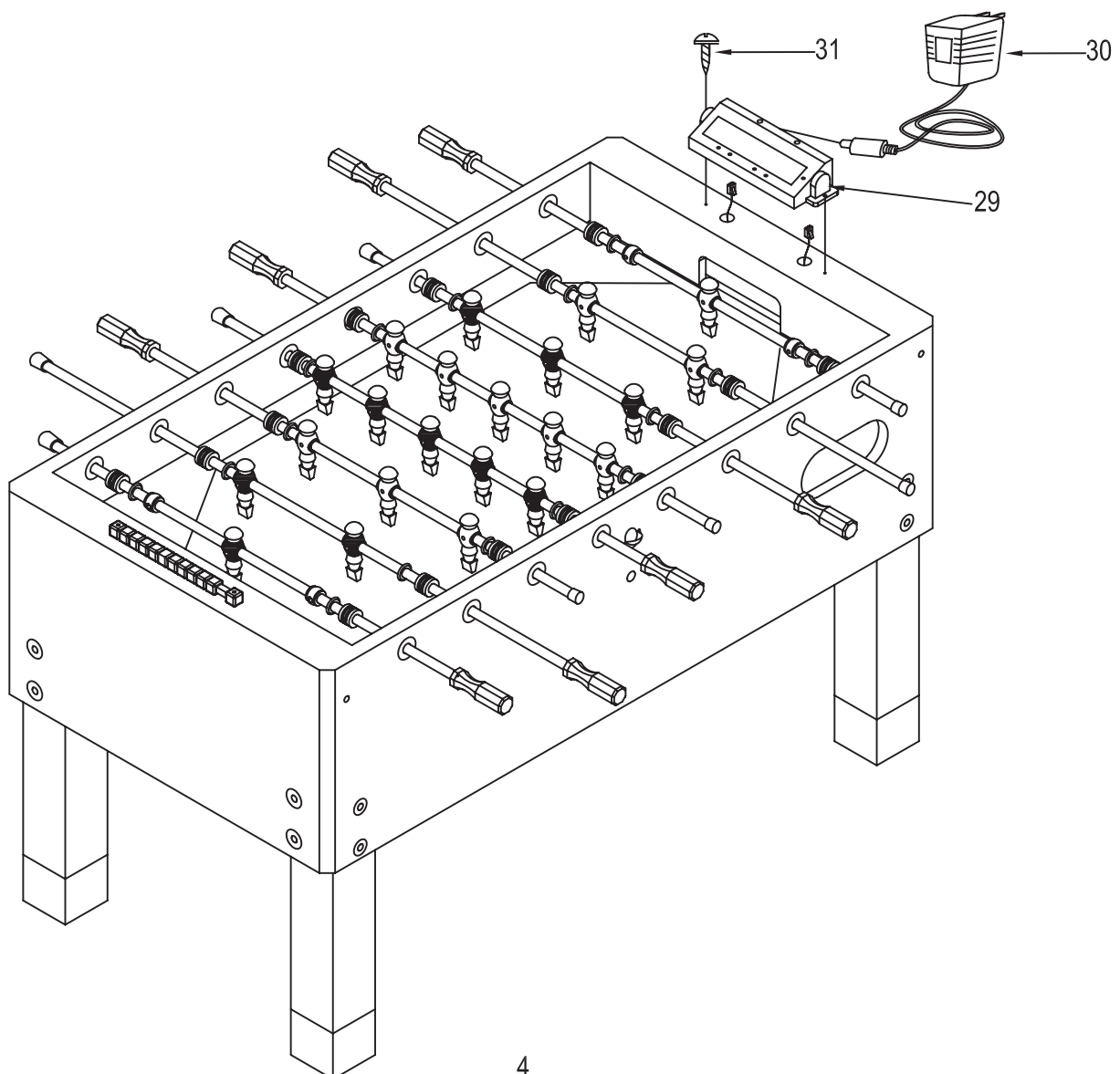



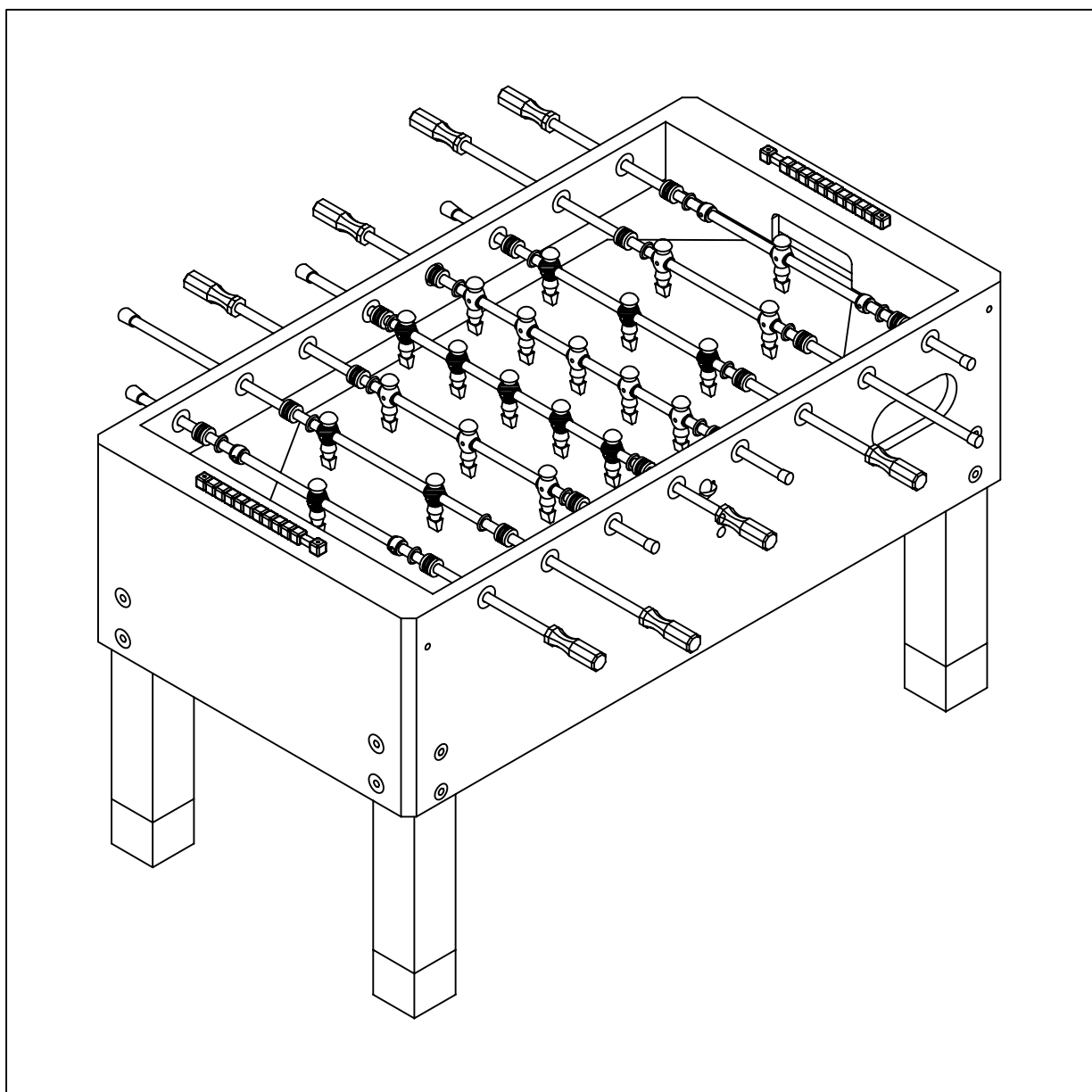





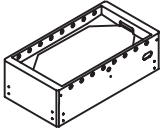
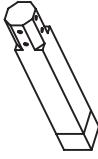
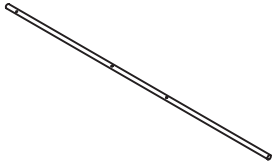
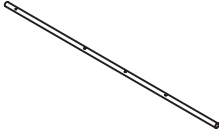
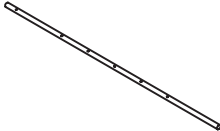

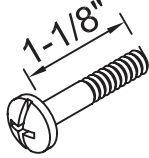



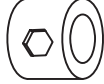
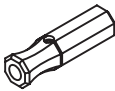

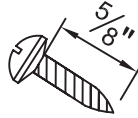
# SOCCER TABLE "PROFI"

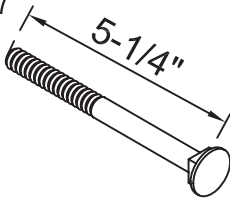
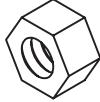
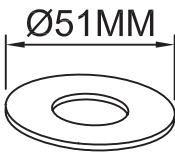

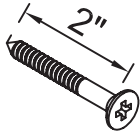
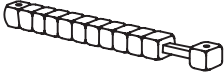
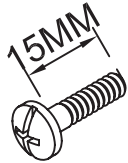
Item-No.: AUT-5913

Parts List

<p>#1</p>  <p>Main frame 1 piece</p>	<p>#2</p>  <p>Leg 4 pieces</p>	<p>#3</p>  <p>Two Player Rod 2 pieces</p>	<p>#4</p>  <p>Three Player Rod 4 pieces</p>
<p>#5</p>  <p>Five Player Rod 2 pieces</p>	<p>#6</p>  <p>Home players 11 pieces</p>	<p>#7</p>  <p>Visit players 11 pieces</p>	<p>#8</p>  <p>8#X1-1/8" Screw 26 pieces</p>
<p>#9</p>  <p>Lock Nut 26 pieces</p>	<p>#10</p>  <p>5/8"X36MM plastic Washer 16 pieces</p>	<p>#11</p>  <p>Rod end cap 8 pieces</p>	<p>#12</p>  <p>Stop ring 4 pieces</p>
<p>#13</p>  <p>Rod Handle 8 pieces</p>	<p>#14</p>  <p>Bumper 16 pieces</p>	<p>#15</p>  <p>8#X5/8" Phillips Head Screw 6 pieces</p>	<p>#16</p>  <p>Ball entry cup 2 pieces</p>
<p>#17</p>  <p>3/8"X5-1/4" bolt 16 pieces</p>	<p>#18</p>  <p>3/8" Lock Nut 16 pieces</p>	<p>#19</p>  <p>1/2"X51MM Washer 16 pieces</p>	<p>#20</p>  <p>3/8"X25MM Washer 16 pieces</p>
<p>#21</p>  <p>3/8" washer 16 pieces</p>	<p>#22</p>  <p>F4X2" Screw 4 pieces</p>	<p>#23</p>  <p>Scoring system 2 pieces</p>	<p>#24</p>  <p>T5X15MM Bolt 8 pieces</p>

<p>#25</p>  <p>Soccer Ball 4 pieces</p>	<p>#26</p>  <p>Wrench 1 piece</p>	<p>#27</p>  <p>Leg leveler 4 pieces</p>	<p>#28</p>  <p>Cover cap 2 pieces</p>
--	--	--	--

Step 1:

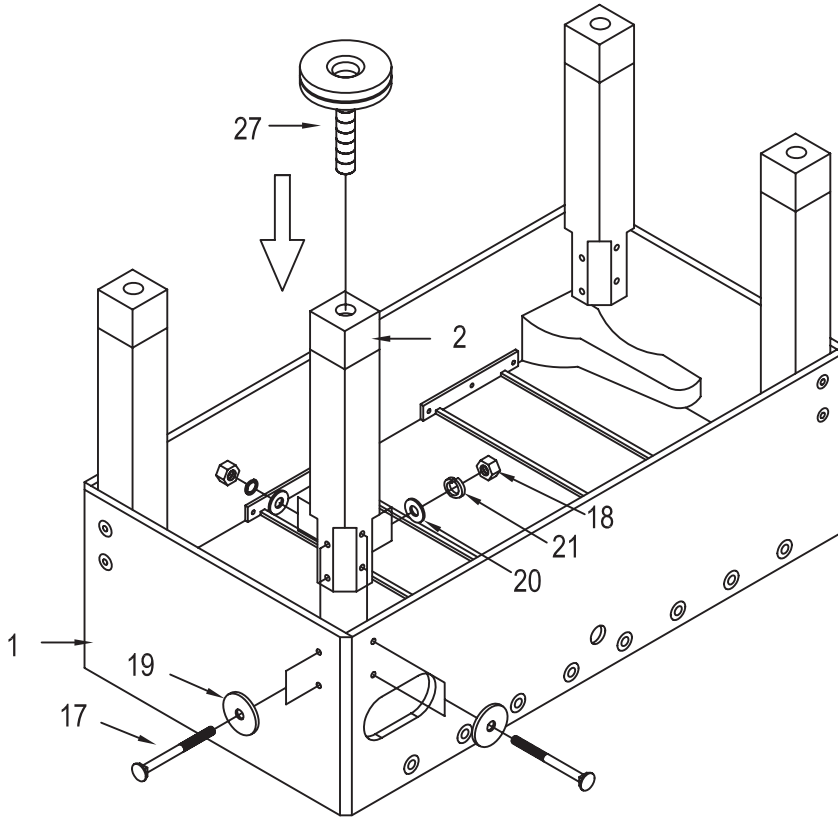



Step 2:

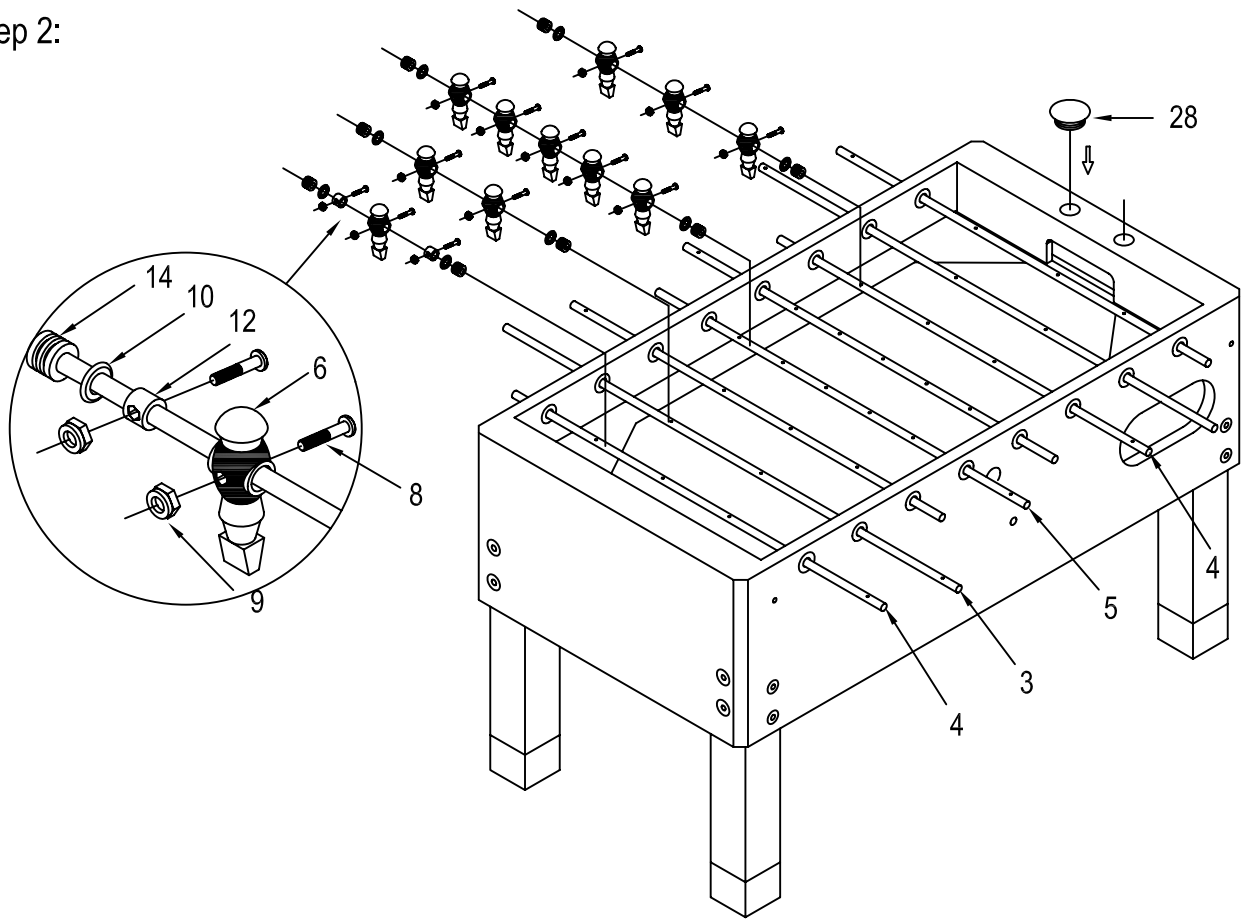

Step 3:

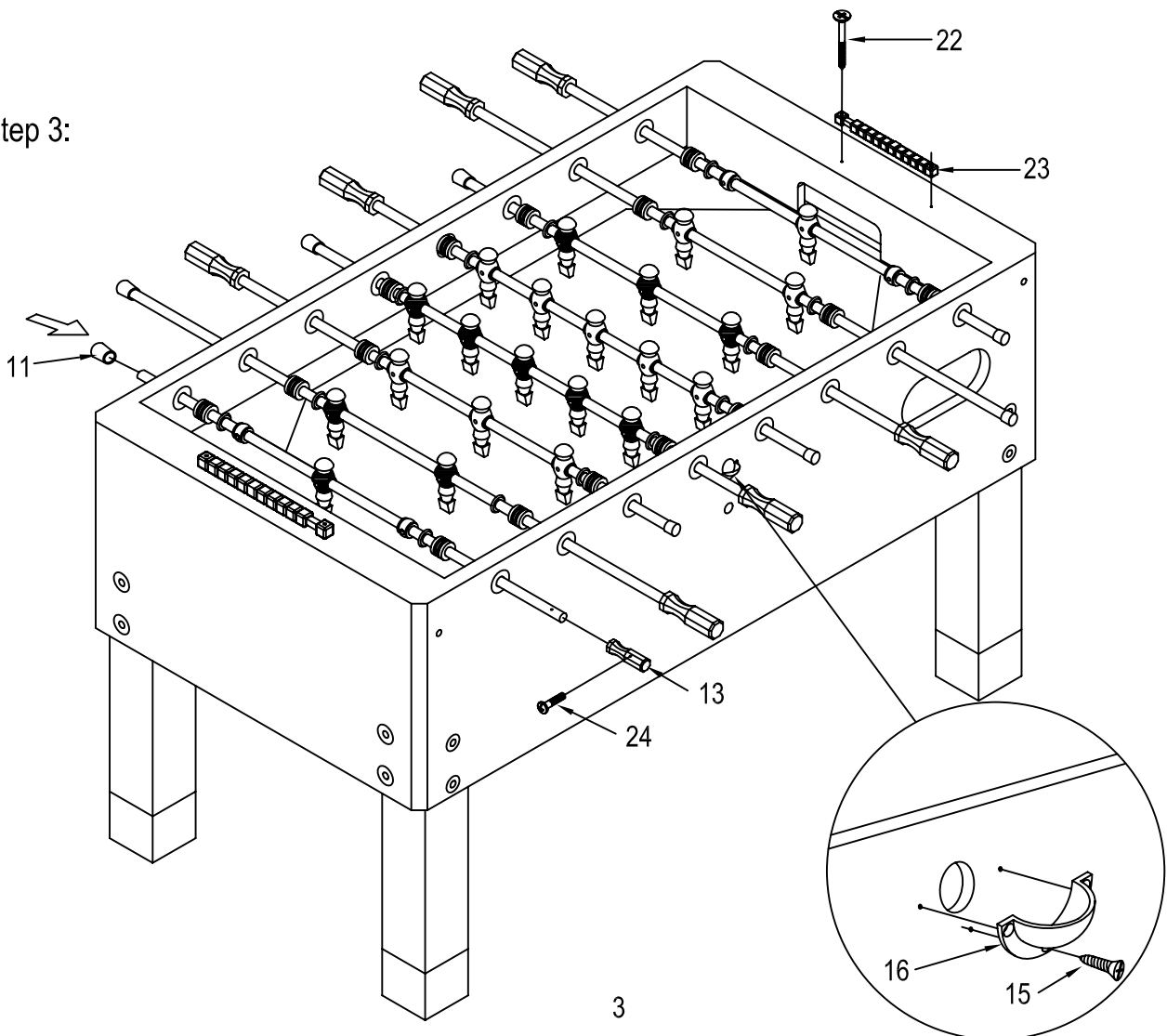

# Optional:

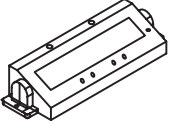
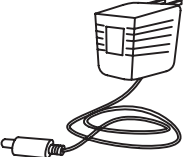
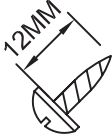
<p>#29</p>  <p>Score board 1 piece</p>	<p>#30</p>  <p>Adapter 1 piece</p>	<p>#31</p>  <p>T4x12MM Screw 2 pieces</p>
---	---	---

