

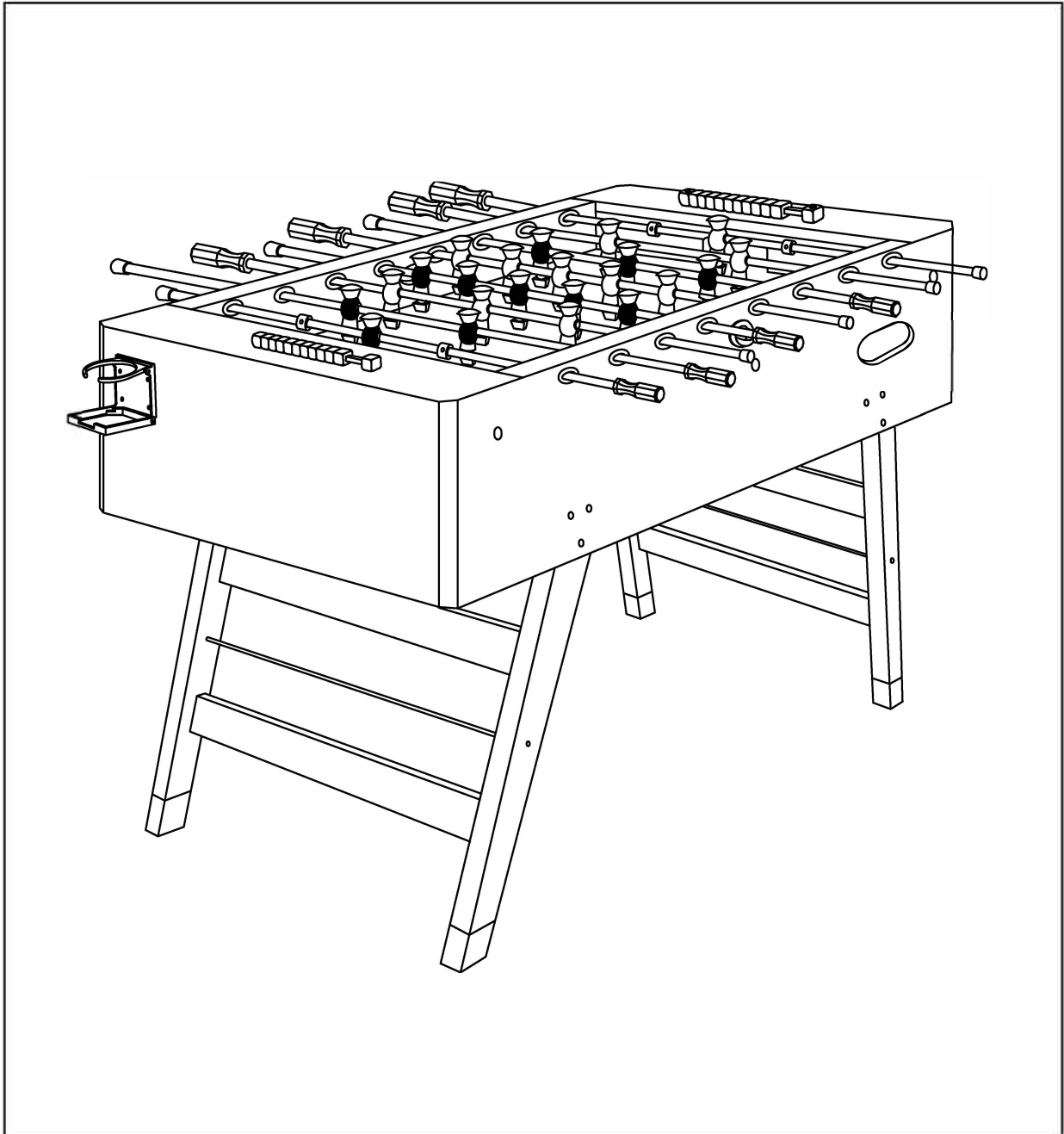

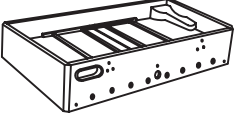

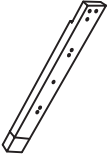

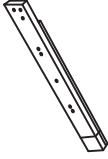

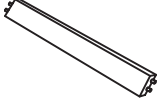
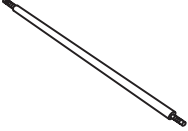



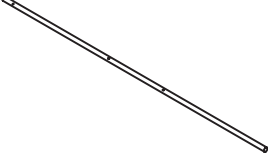
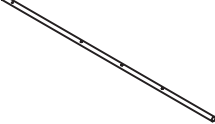
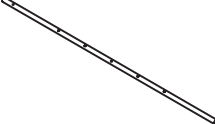









TISCHKICKER „WINNER“

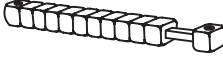
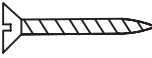

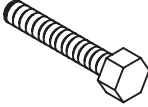
Art.-Nr.: 3500008

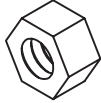
Bauteile

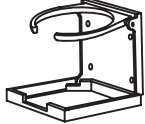
<p>#1</p>  <p>Korpus 1 Stück</p>	<p>#2</p>  <p>Linkes Bein 2 Stück</p>	<p>#3</p>  <p>Rechtes Bein 2 Stück</p>	<p>#4</p>  <p>Querstrebe 4 Stück</p>
<p>#5</p>  <p>Querstrebe 2 Stück</p>	<p>#6</p>  <p>Unterlegscheibe 4 Stück</p>	<p>#7</p>  <p>Abdeckung Mutter 4 Stück</p>	<p>#8</p>  <p>Unterlegscheibe 4 Stück</p>
<p>#9</p>  <p>Stange für 2 Spieler 2 Stück</p>	<p>#10</p>  <p>Stange für 3 Spieler 4 Stück</p>	<p>#11</p>  <p>Stange für 5 Spieler 2 Stück</p>	<p>#12</p>  <p>Unterlegscheibe 16 Stück</p>
<p>#13</p>  <p>Puffer 16 Stück</p>	<p>#14</p>  <p>Schraube 26 Stück</p>	<p>#15</p>  <p>Mutter 26 Stück</p>	<p>#16</p>  <p>Stelling 4 Stück</p>
<p>#17</p>  <p>Kickerfigur Heim 11 Stück</p>	<p>#18</p>  <p>Kickerfigur Gast 11 Stück</p>	<p>#19</p>  <p>Balleinwurfschale 2 Stück</p>	<p>#20</p>  <p>Schraube 14 Stück</p>
<p>#21</p>  <p>Kickergriff 8 Stück</p>	<p>#22</p>  <p>Schraube 8 Stück</p>	<p>#23</p>  <p>Torzählwerk 2 Stück</p>	<p>#24</p>  <p>Schraube 4 Stück</p>

<p>#25</p>  <p>Schraube 12 Stück</p>	<p>#26</p>  <p>Unterlegscheibe 24 Stück</p>	<p>#27</p>  <p>Unterlegscheibe 12 Stück</p>	<p>#28</p>  <p>Mutter 12 Stück</p>
<p>#29</p>  <p>Stangenkappe 8 Stück</p>	<p>#30</p>  <p>Getränkehalter 2 Stück</p>	<p>#31</p>  <p>Kickerball 4 Stück</p>	<p>#32</p>  <p>Sechskantschlüssel 1 Stück</p>

Aufbauanleitung

Schritt 1:

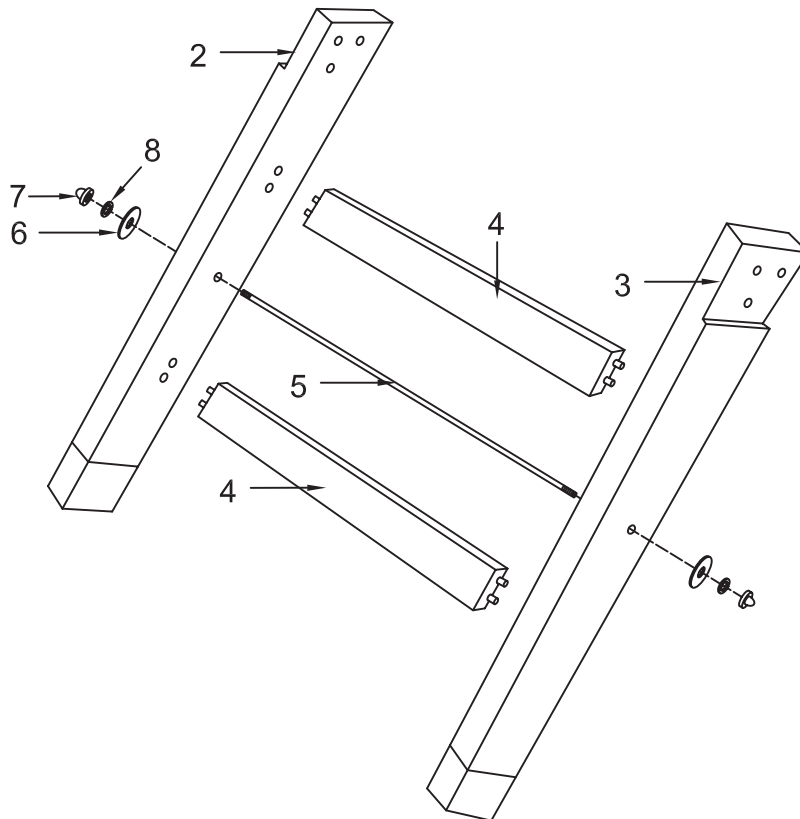

Schritt 2:

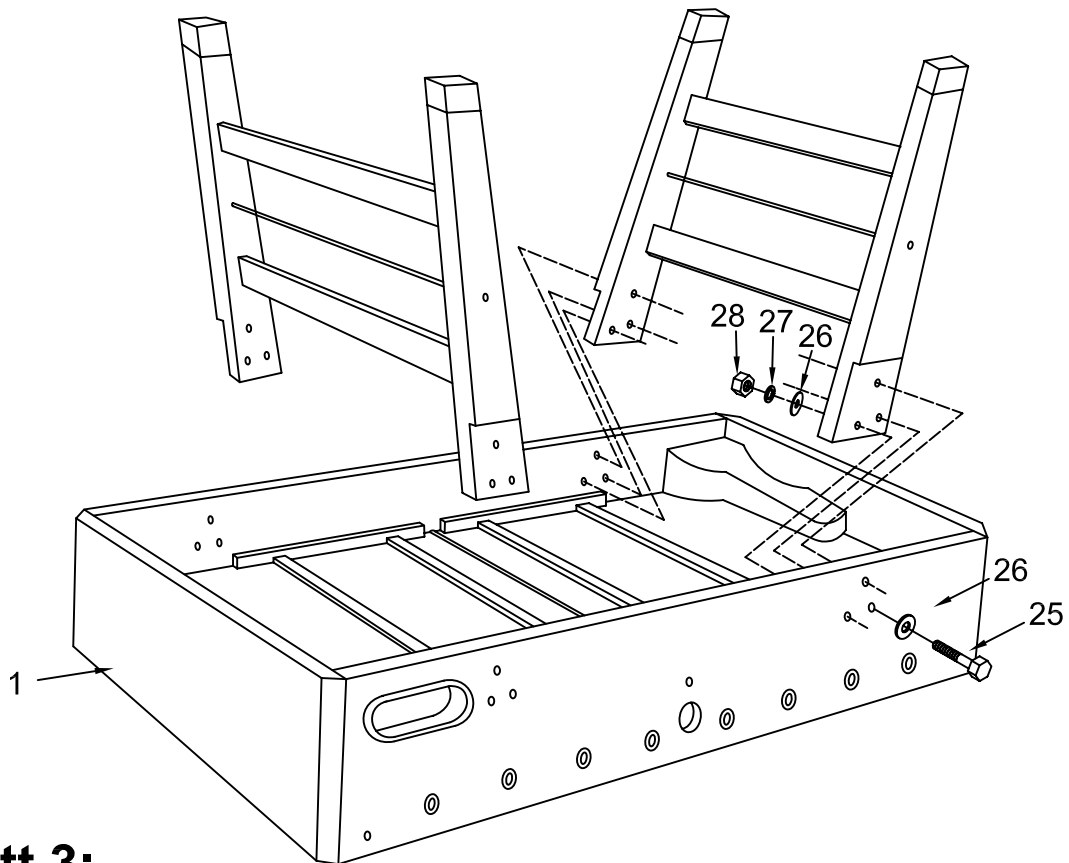

Schritt 3:

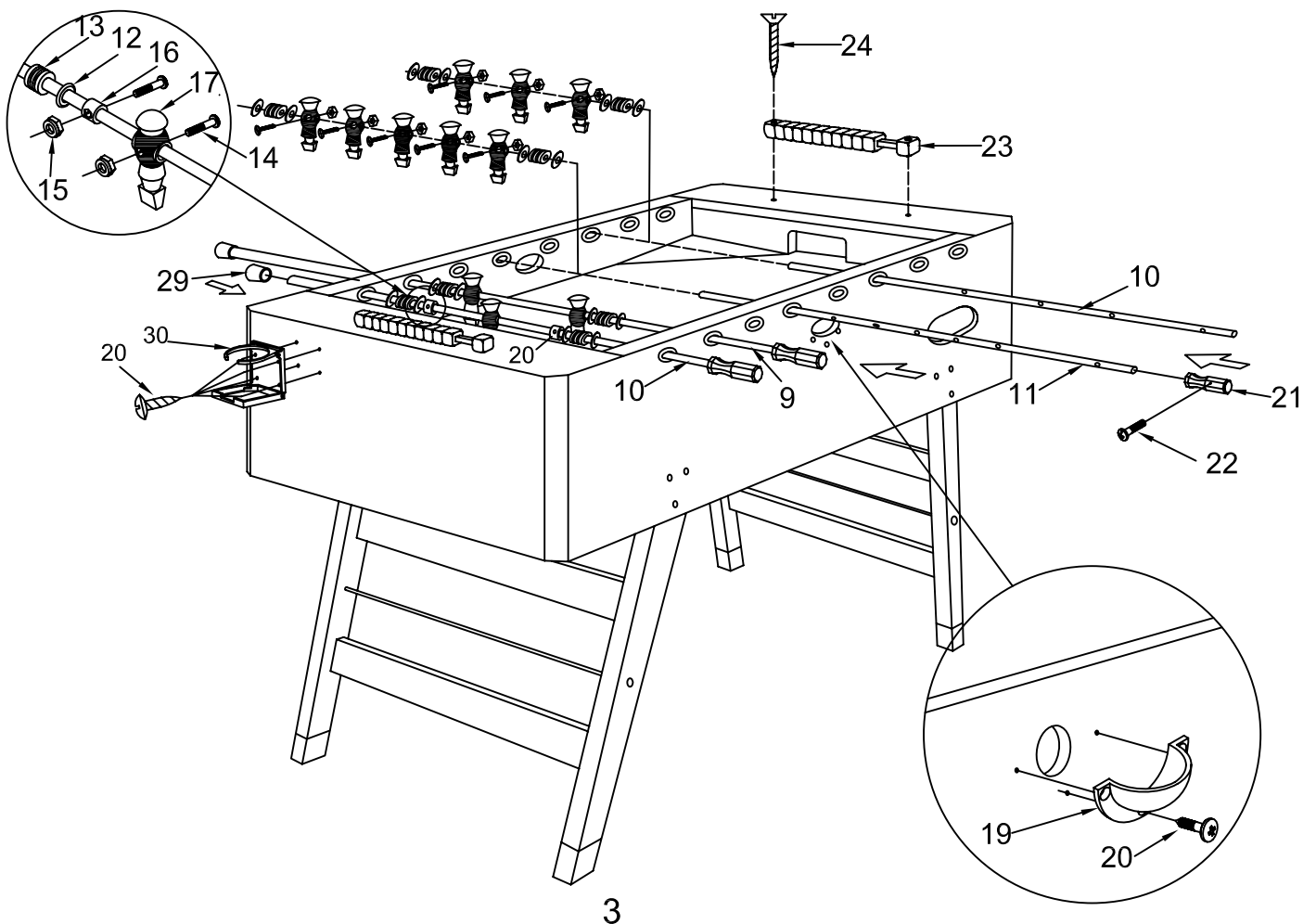



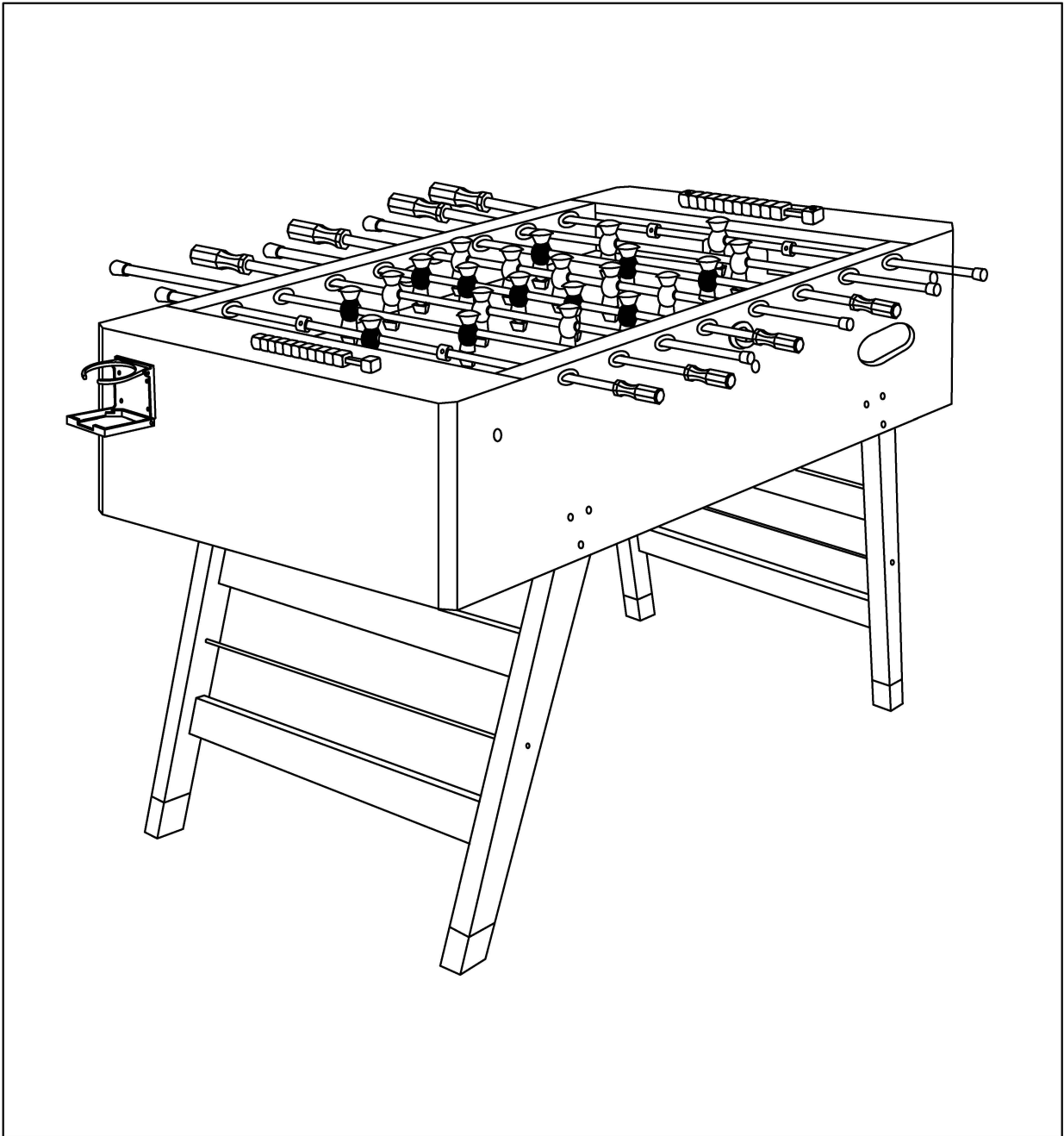





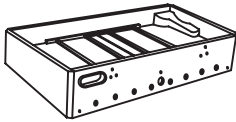
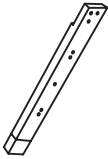
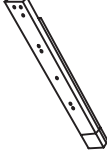
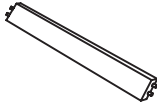
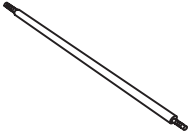
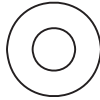

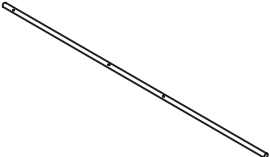
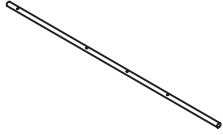
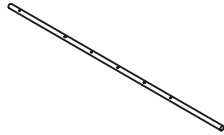

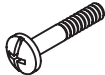



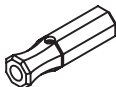

SOCCER TABLE “WINNER”

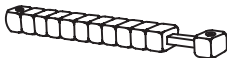
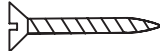

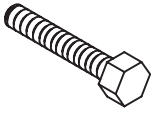
Item-No.: 3500008

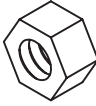
Parts List

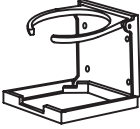
<p>#1</p>  <p>Main Frame 1 piece</p>	<p>#2</p>  <p>Left Leg 2 pieces</p>	<p>#3</p>  <p>Right Leg 2 pieces</p>	<p>#4</p>  <p>Leg Panel 4 pieces</p>
<p>#5</p>  <p>5/16" Support Rod 2 pieces</p>	<p>#6</p>  <p>5/16"x23MM Washer 4 pieces</p>	<p>#7</p>  <p>5/16" Cap Nut 4 pieces</p>	<p>#8</p>  <p>5/16" Split Lock Washer 4 pieces</p>
<p>#9</p>  <p>Two Player Rod 2 pieces</p>	<p>#10</p>  <p>Three Player Rod 4 pieces</p>	<p>#11</p>  <p>Five Player Rod 2 pieces</p>	<p>#12</p>  <p>5/8"X38MM Plastic Washer 16 pieces</p>
<p>#13</p>  <p>Bumper 16 pieces</p>	<p>#14</p>  <p>8#X1-1/8" Screw 26 pieces</p>	<p>#15</p>  <p>Lock Nut 26 pieces</p>	<p>#16</p>  <p>Stop ring 4 pieces</p>
<p>#17</p>  <p>Home players 11 pieces</p>	<p>#18</p>  <p>Visit players 11 pieces</p>	<p>#19</p>  <p>Ball Entry Cup 2 pieces</p>	<p>#20</p>  <p>8#X5/8" Phillips Head Screw 14 pieces</p>
<p>#21</p>  <p>Rod Handle 8 pieces</p>	<p>#22</p>  <p>T5X15MM Bolt 8 pieces</p>	<p>#23</p>  <p>Score Rack 2 pieces</p>	<p>#24</p>  <p>F4*1-1/2" Screw 4 pieces</p>

<p>#25</p>  <p>3/8"X3" Bolt 12 pieces</p>	<p>#26</p>  <p>5/8"X25MM Washer 24 pieces</p>	<p>#27</p>  <p>3/8" Split Lock Washer 12 pieces</p>	<p>#28</p>  <p>3/8" Lock Nut 12 pieces</p>
<p>#29</p>  <p>Rod End Cap 8 pieces</p>	<p>#30</p>  <p>Drink Holder 2 pieces</p>	<p>#31</p>  <p>Soccer Ball 4 pieces</p>	<p>#32</p>  <p>Wrench 1 piece</p>

Step 1:

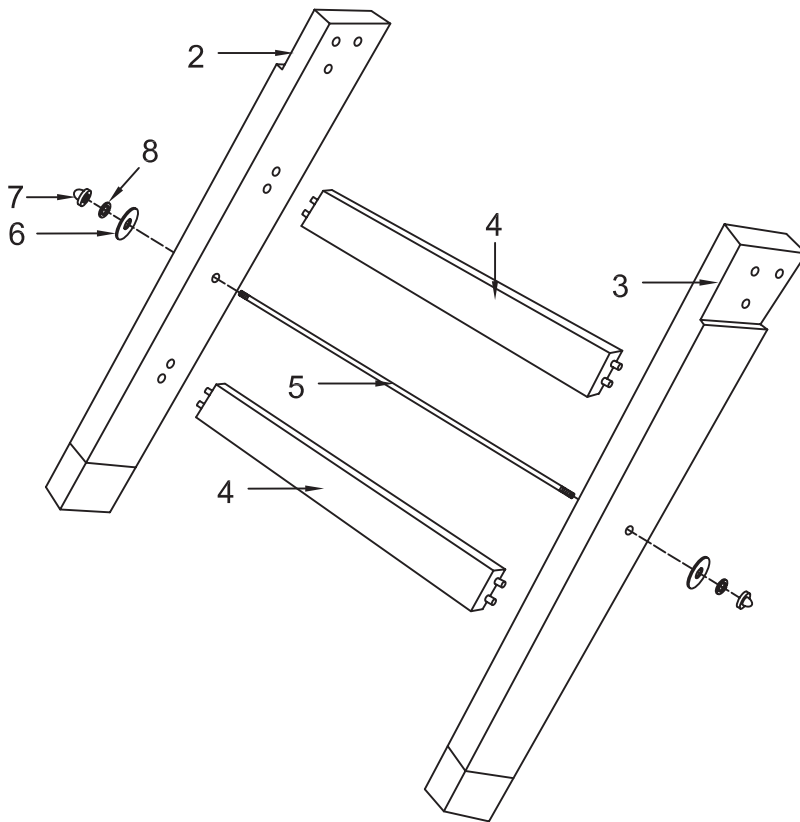

Step 2:

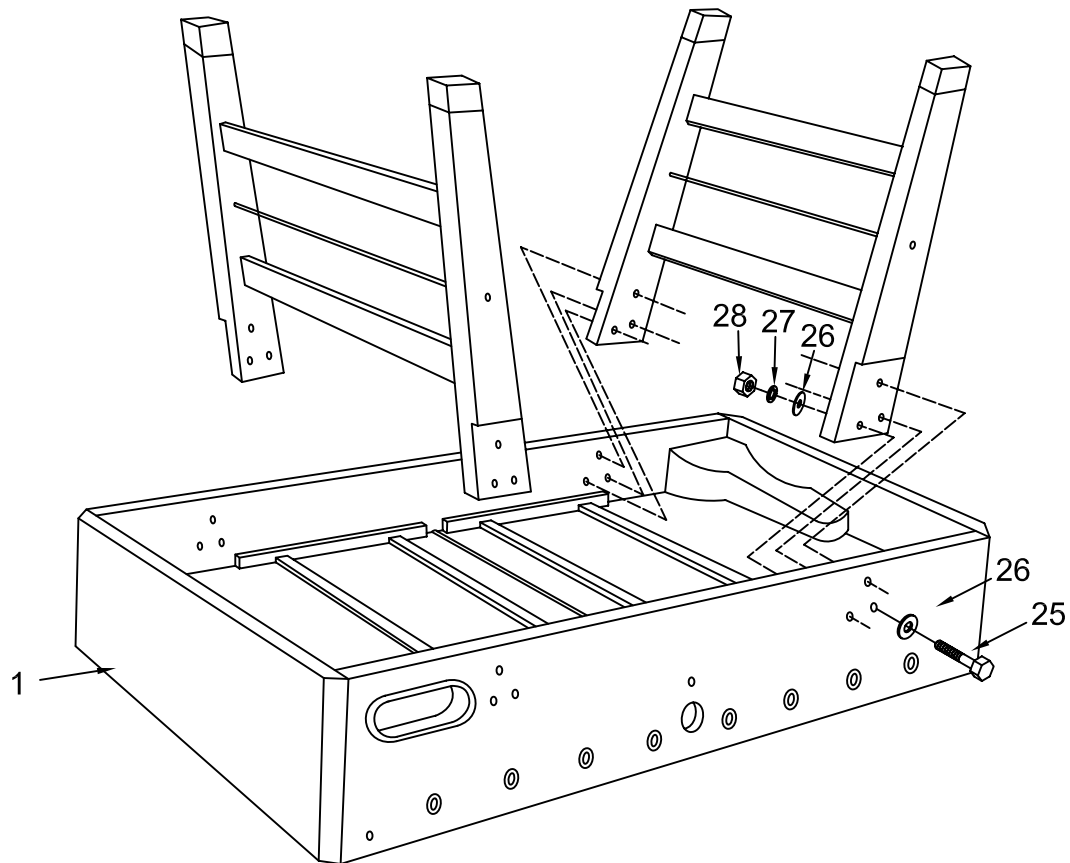

Step 3:

