







1  Oberteil 1 Stück	2  Korb 1 Stück	3  Fuß 1 Stück	4  Obere Stange 1 Stück	5  Untere Stange 1 Stück	6  M8 x65mm Schraube 3 PCS
7  M8x0mm Schraube 1 Stück	8  4 & 5 mm Innensechskant- schlüssel: je 1 Stück	9  MSx6mm Schraube 4 Stück	10  Schlüssel 1 Stück	11  M8 Mutter 4 Stück	12  Plastikdeckel 1 PC

Material: Pulverbeschichteter Stahlkorb, pulverbeschichteter Stahl-Mittelpfosten, pulverbeschichteter Sockel, verzinkte Stahlketten

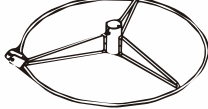
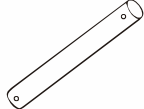
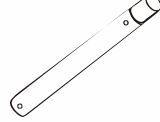
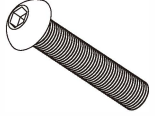
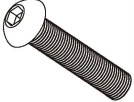
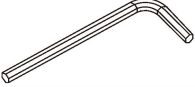



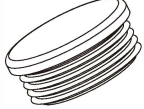

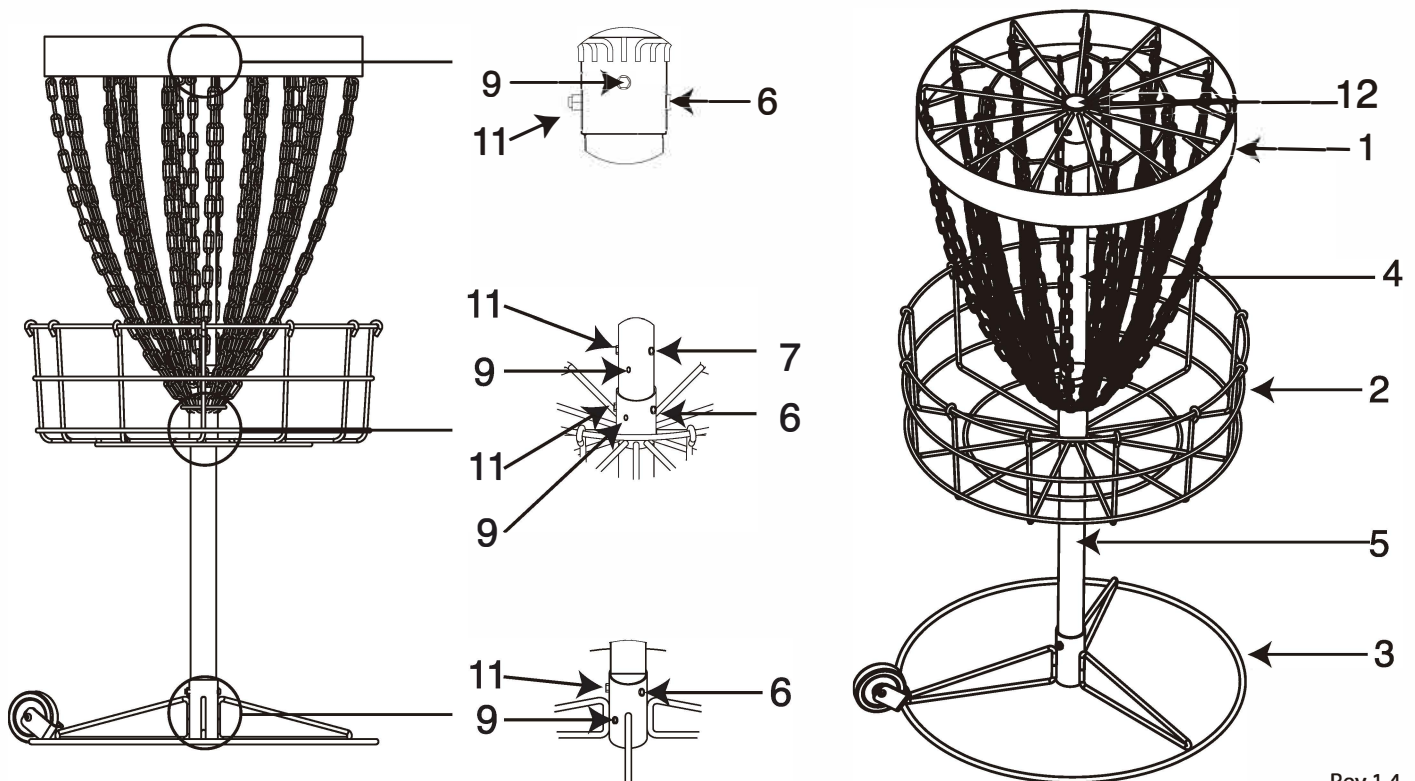
Aufbauanleitung

- 01 Montiere die untere Platte (5) an der Basis (3) und zieh sie mit der Mutter (11) und der Schraube (6) fest. Setz die Spanschraube (9) ein und ziehe sie fest.
- 02 Montiere den Korb (2) mit der Mutter (11) und der Schraube (7) an der unteren Stange (5).
- 03 Montiere die obere Stange (4) mit der Mutter (11) und der Schraube (7) an der unteren Stange (5).
- 04 Montiere die obere Baugruppe (1) mit der oberen Stange (4) unter Verwendung der Mutter (11) und der Schraube (6). Setz die Spanschraube (9) ein und ziehe sie fest.
- 05 Zum Schluss setz die obere Kappe (12) auf den Korb.

Jetzt kannst du anfangen zu spielen!

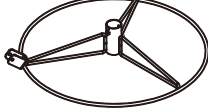
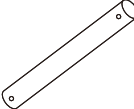
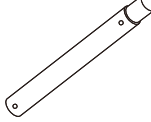
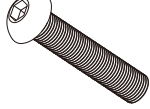
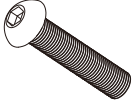

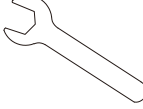
L64 Trainer Parts List

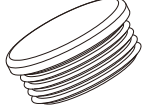
1  Top 1 PC	2  Basket 1 PC	3  Base 1 PC	4  Top Pole 1 PC	5  Bottom Pole 1 PC	6  M8 x65mm Bolt 3 PCS
7  M8x60mm Bolt 1 PC	8  4 & 5mm Allen Tool 1 PC Each	9  M8x6mm Bolt 4 PCS	10  Hand Wrench 1 PC	11  M8 Nut 4 PCS	12  Plastic Cover 1 PC

Materials: Powder Coated Steel Basket, Powder Coated Steel Center Pole, Powder Coated Steel Base, Zinc Plated Steel Chains

Assembly Instructions

- 01** Assemble the bottom pole (5) to the base (3) and tighten using the nut (11) and bolt (6). Insert the tension bolt (9) and tighten it.
- 02** Assemble the basket (2) to the bottom pole (5) using the nut (11) and bolt (6).
- 03** Assemble the Top Pole (4) into the Bottom Pole (5) using the nut (11) and bolt (7).
- 04** Assemble the Top Assembly (1) with the Top Pole (4) using the nut (11) and bolt (6). Insert the tension bolt (9) and tighten it.
- 05** Finish up by placing the Top Cap (12) into the top of the basket.

Now you can start to play!

